



PRODUCTS THAT MOVE YOU

**OUTDOOR GAMES
2025**

MASGAMES
Outdoor games



AT MASGAMES WE ARE MANUFACTURERS AND HAVE OUR OWN BRAND OF OUTDOOR GAMES. OUR PRODUCTS OFFER AN EXCELLENT PRICE-QUALITY RATIO.

In **MASGAMES** We manufacture outdoor games and wooden street furniture for the Horeca channel (Hotels, Restaurants, Communities...) or for demanding individuals.

Wood is the main raw material in most of our items. **Playgrounds, swings, wooden playhouses, rocking chairs, trampolines and garden furniture** are some of our proposals.

Our products are "Made in Barcelona", locally produced, nice design and with the European standards of quality, safety and sustainability.

Masgames Active Toys, SL **Born 20 years ago**. Our CEO, during a stay in the United Kingdom, realized the difficulty in acquiring garden games in our country despite the good climate we had. We are currently a team of professionals converted **intomanufacturers of our own games and outdoor furniture**, with our own engineering department and capable of designing strong and beautiful outdoor products.

Our team works in **the design and manufacture of both public use products and household items home use**. We are also open to the **possibility of working on custom project designs specific**.

An example of this is our **giant wooden letters**, large-format structures that at the same time They can house games such as slides or climbing walls, among other alternatives.

We seek the satisfaction of our clients also in the medium/long term. For our team to provide a good human treatment and paying attention to details are very important aspects when it comes to providing good service. Toy store chains, garden centers, online platforms that are leaders in their sector, shopping centers and convenience stores.

DIY are just some of our clients. Do you want to be a distributor of Masgames products?

WE ARE HERE TO HELP YOU!

To offer a good service to our customers, our working methodology:

- Manufacture our own products
 - Have stock
 - Give good advice
 - Act quickly
- Work effectively, honestly and professionally



CONTACT OUR LOCAL DISTRIBUTOR:

www.masgames.com

INDEX

SWINGS

METAL SWINGS
WOODEN SWINGS
SWING ACCESSORIES

06

WOODEN
PLAYGROUNDS

WOODEN PLAYGROUNDS
PLAYGROUND ACCESSORIES
INFORMATION TABLE

23

WOOD GAMES

LITTLE HOUSES
OUTDOOR WOODEN KITCHENS
CHALKBOARDS
SANDBOXES
GOALS
ZIPLINES
GROWING TABLES
SLIDES

64

PRODUCTS
PUBLIC USE

COMMERCIAL USE PLAYGROUNDS
GIANT LETTERS

80

CUSTOM MADE
PRODUCTS

CUSTOM PROJECTS

100

OUR WOOD

The wood used in MASGAMES swings and playgrounds has been selected from the best fir and pine trees. All the wood used has been treated with level IV autoclave impregnation to prevent wood rot, deterioration due to humidity and possible insect infestations, with a 10-year guarantee. This method used is non-toxic and free of arsenic and has a darker wood colour that makes it more beautiful and greater quality and durability. These are common procedures for the wood used in swings and playgrounds.

Wood is a living material that expands and contracts depending on temperature and humidity conditions, and throughout the year the cracks can be more or less large and long. They will be at their maximum in summer and in winter, if the climate is humid, they will be reduced. The cracks can have a width of up to 3% of the trunk's circumference and can reach the centre of the wood. These cracks have been taken into account in the resistance calculations of each component.

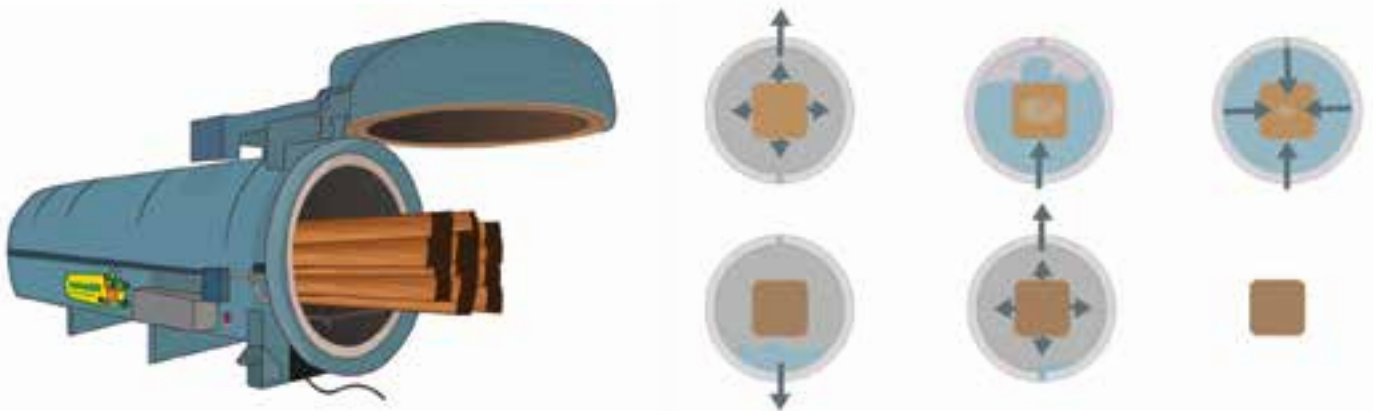

In round or square wooden swings, a certain amount of clearance can be seen between the metal corners and the wood. This clearance is necessary so that the wood can expand and it is very important that it is not blocked, and it is also very important that the cracks are not covered.

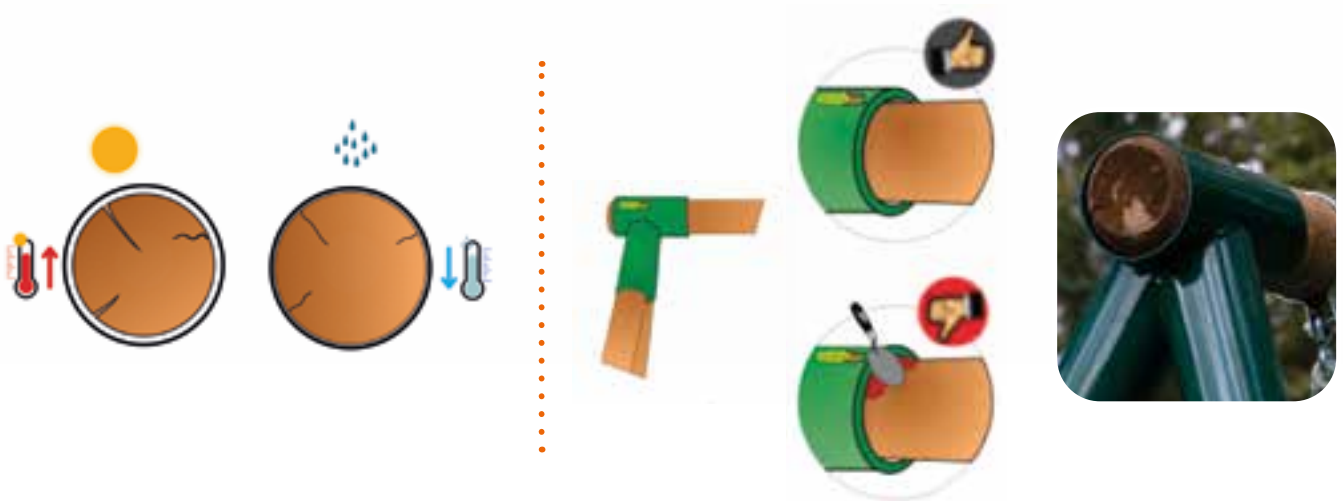

Watch the VIDEO!
For more information
on our wood.



Differences between round or square wood:

- Round wood has been selected from young trees. It is so resistant and less expensive than the wood coming from old trees. This wood comes from renewable forests, but it has more cracks.
- The use of square wood reduces the appearance of cracks on the surface. This is because the wood is cut mainly from the edges towards its centre. In addition, the wood has been dried naturally before being cut in order to avoid possible shrinkage and cracks.
- The strength and solidity is approximately the same in both forms

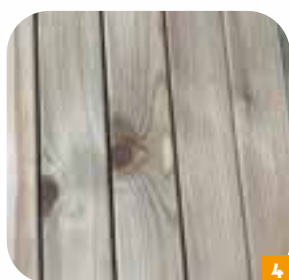
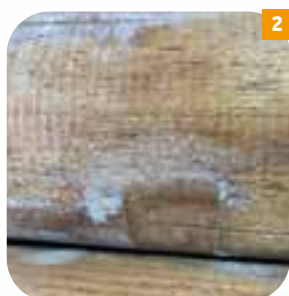

The wood conditions that are completely normal and do not modify the functionality of the product or its quality are the following:

1. CRACKS IN THE WOOD*

Expansion and/or contraction of wood. These are completely normal and necessary.

2. WHITE STAINS ON WOOD*

Surface mold from storage. Can be cleaned with a dry cloth and exposure to the elements.

3. KNOTS IN THE WOOD*

They are a peculiarity of wood, completely normal.

4. DIFFERENCES IN COLOR AND GREENISH SURFACE SPOTS*

They are due to autoclave treatment, but with exposure to the elements the color will become more uniform.

*All these peculiarities in the wood are normal and therefore cannot give rise to claims.

Review and maintenance:

- It is advisable to regularly review the games, in order to detect possible damage from rot or rust, especially the fixing components of the structures and readjust them if necessary.
- We recommend that you remove all accessories during the winter, i.e. seats, rings, ropes, etc. and store them in a sheltered place.
- The swings can tilt due to their continuous swaying, which is why it is recommended to check the anchors periodically.

METAL SWINGS

Metal garden swings, easy to assemble and ready for the outdoors. The swing frame is made of galvanised metal and combines two shades of green to match the seats.



Individual swing **BABOL**

150 cm (length) x 77.5 cm (width) x 180 cm (height)
Crossbar is 90 cm

Ref: MA400201



Double swing **OLEA**

213 cm (length) x 146 cm (width) x 180 cm (height)
Crossbar is 165 cm.

Ref: MA400202

OLEA + BABY SEAT

Ref: MA400202B

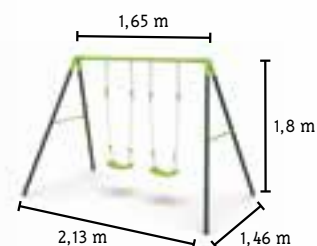

Triple swing **GINGO**

290 cm (length) x 162 cm (width) x 195 cm (height)
Crossbar is 215 cm.

Ref: MA400203

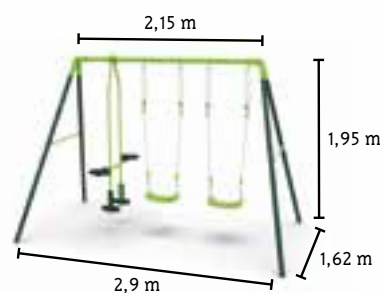

GINGO + BABY SEAT

Ref: MA400203B



Watch the VIDEO!
And discover our
metal swings!



Anchor set metal swing

Set of 4 anchors to screw into concrete floors, for MASGAMES metal swings.

Ref: MA400200



WOODEN SWINGS

KILA

3-9
years

This swing is designed for children from 3 to 9 years old. It is made of pine wood carved in a round shape, resistant and treated for the outdoors.

Dimensions: 1.57 m [length] x 1.66 m [width] x 1.92 m [height]. The length of the crossbar is 100 cm.
Posts: 80 mm diameter.
Crossbar: 100 mm diameter.

Includes 1 swing with individual plastic seat and ropes. Also includes metal connecting pieces, anchors and screws.
Approved for the garden of a private home.

Ref: MA700003

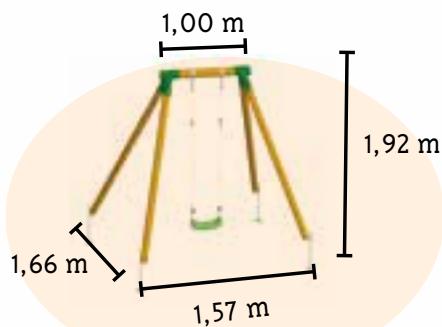

The maximum weight of the seat user individual of the swing are **50 kg**

SWINGS

Kila with baby seat

Includes 2 seats:

- A flat seat
- A baby seat

Ref: MA700004





KADI

The MASGAMES KADI swing is a strong and robust swing, made from treated wood for outdoor use and offering a very competitive price-quality ratio. Unlike the KIBO swing, the KADI swing is a smaller structure but is a very strong swing that offers a lot of stability. Anchors are included to fix it to the ground.



Dimensions: 2.57 m. [length] x 1.66 m. [width] x 1.92 m. [height]

The structure includes:

- 80 mm round wooden sticks.
- 100 mm crossbar.
- Plastic seats with synthetic ropes.
- 2 Corners, 4 anchors, screws.

Ref: MA700046

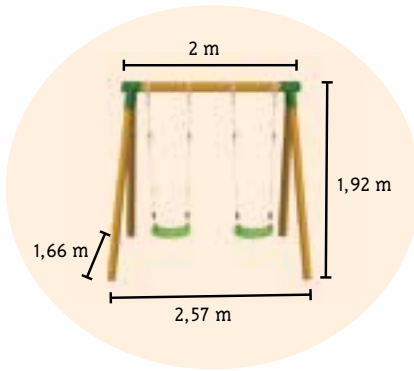

The maximum weight of the seat user individual of the swing are **50 kg**



200 x 22 x 20 cm



40 x 40 x 30 cm

Kadi with baby seat

Includes 3 seats:

- Two flat seats
- A baby seat

Ref: MA700047

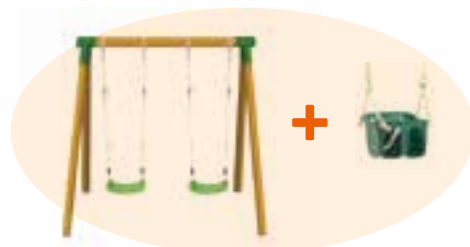

200 x 22 x 20 cm



50 x 30 x 40 cm



KADI DELUXE

This version of the KADI swing has a longer crossbar and includes a rope ladder on the side for extra fun!

Dimensions: 2.78 m. (length) x 1.66 m. (width) x 1.92 m. (height)

The structure includes:

- 80 mm round wooden sticks.
- 100 mm crossbar.
- Plastic seats with synthetic ropes.
- Rope ladder.
- Corners and anchors.

Ref: MA700048

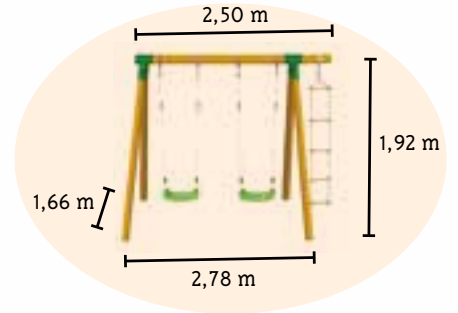

250 x 22 x 20 cm



40 x 40 x 30 cm



The maximum weight of the seat user individual of the swing are **50 kg**

Kadi Deluxe with baby seat

Includes 3 seats:

- Two flat seats
- A baby seat
- A rope ladder

Ref: MA700049

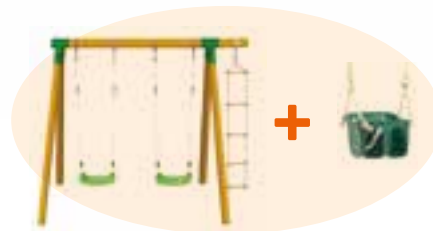

250 x 27 x 18 cm



50 x 30 x 40 cm



KIBO

The classic double swing with excellent value for money. The wood used in MASGAMES swings and playgrounds has been selected from the best firs and pines and has been treated to resist solar radiation. The method used is non-toxic and arsenic-free. It has a darker wood color that makes it more beautiful, of higher quality and durability.

- Measurements: 2.73 m (length) x 1.94 m (width) x 2.21 m (height).
- 2 plastic seats and ropes.
- Metal connecting pieces, anchors and screws.
- Posts: 80 mm and 100 mm (diameter).



Ref: MA700026



The maximum weight of the seat user individual of the swing are **70 kg**

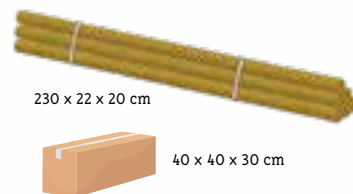
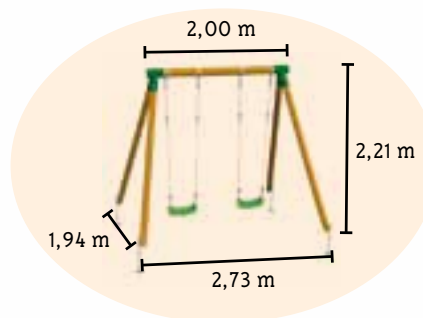

Kibo with baby seat

The classic Kibo swing with baby seat.

Includes:

- Two flat seats
- A baby seat

Ref: MA700036



Kibo Plus

Double base structure with UFO seat.

Includes:

- 1 UFO swing seat
- Two plastic seats and ropes

Ref: MA700028

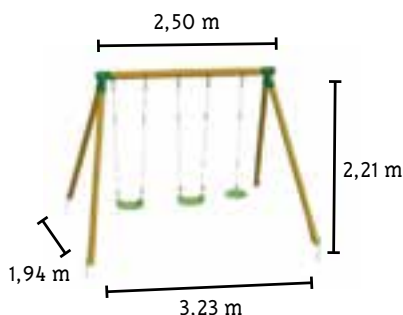

Kibo Deluxe

Double base structure with rope ladder

Includes:

- 1 rope ladder
- Two plastic seats and ropes

Ref: MA700029

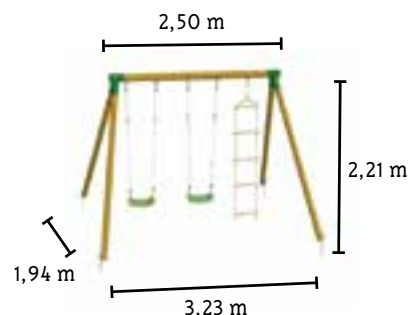



ETNA

Triple base structure. The Masgames Etna Triple structure is a tall and strong swing, with three play elements.

Measures:

3.43m. [length] x 1.94 m. [width] x 2.21 m. [high]

Ref: MA700015

- Includes 3 plastic seats and ropes and 1 set of corners and anchors.
- The round wooden posts have a measurement of 80mm at the legs and 100mm [diameter] the top post

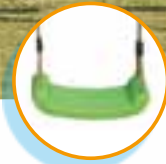

The maximum weight of the seat user individual of the swing are **70 kg**

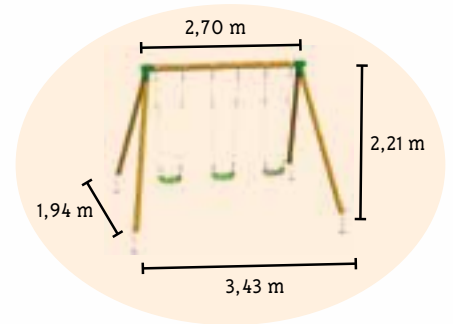

Etna with baby seat

- Triple base structure with baby seat.
- Includes 3 plastic seats and strings.
 - 1 baby seat and ropes
 - 1 set of corners and anchors

Ref: MA700025

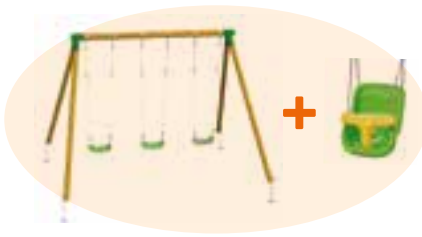

Etna with seat face to face

- Triple base structure with face-to-face seating.
- Includes 2 plastic seats and ropes, 1 double face-to-face metal seat with plastic seats and 1 set of corners and anchors

Ref: MA700018



Double Plus

- Triple base structure with trundle seat.
- Includes 1 plastic seat and ropes, 1 nest seat, 1 set of corners and anchors

Ref: MA700016





FUJI ADULTS

The Fuji swing for adults has been designed so that adults can also swing on it. **It is a strong and tall structure, suitable for adults to swing on as well.**

- Dimensions: 3.36 m [length] x 2.98 m [width] x 2.14 m [height].
- The structure includes poles, anchors and corners and 2 rubber and rope seats or rubber and chains.
- All round wooden posts have a diameter of 100 mm

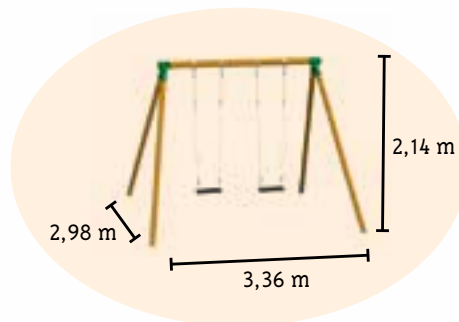

The maximum weight of the seat user individual of the swing are **95 kg**

Ref: MA700050



Ref: MA700083

FUJI individual with rubber seat and ropes

Ref: MA700083

FUJI individual with rubber seat and chains

Fuji with chain seats

The classic swing with a rubber seat and chains.

Includes:

- 2 rubber seats with chains.

Ref: MA700051



The maximum weight of the seat user individual of the swing are **110 kg**





AIKO



The AIKO swing is designed for children from 3 to 9 years old and for small spaces.

It is made of pine wood carved in a very resistant square shape and treated for the outdoors.

- Measurements: 1.70 m [length] x 1.50 m [width] x 1.95 m [height]
- The length of the crossbar is 100 cm.
- Posts: 68x68 mm thick
- Crossbar: 88x88 mm thick
- Includes 1 swing with individual plastic seat and ropes.
- Also includes metal connecting pieces, anchors and screws.

Approved for the garden of a private home.

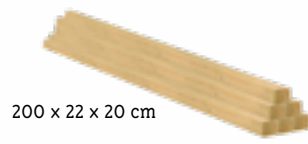

Ref: MA700054

The maximum weight of the seat user individual of the swing are **70 kg**

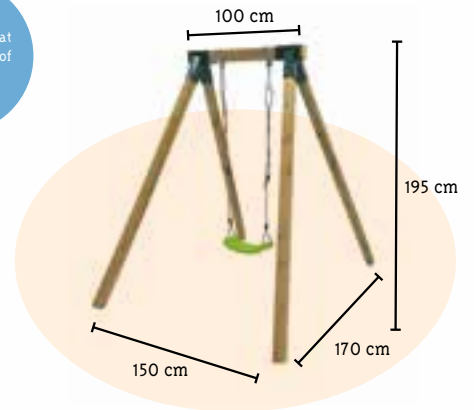

Aiko with baby seat

Includes 2 seats:

- A flat seat
- A baby seat

Ref: MA700055

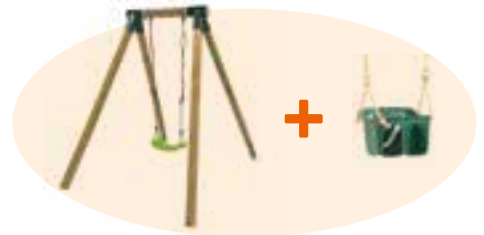



XYLO

The MASGAMES XYLO wooden swing is made of square-cut Nordic wood. The XYLO swing is a structure built without metal corners, with a system of wood and screws the legs are joined to the crossbar making a stable, strong structure. The assembly takes more time compared to the swings that come with corners but thanks to not having the slack that swings with corners have, the swing has less rocking. Square-cut wood has fewer cracks than round wood

This swing structure **includes:**

- 2 flat plastic seats and ropes
- Anchors for sand or grass floors and screws.

The dimensions of the XYLO swing are as follows:

265 cm (length) x 150 cm (width) x 220 cm (height).

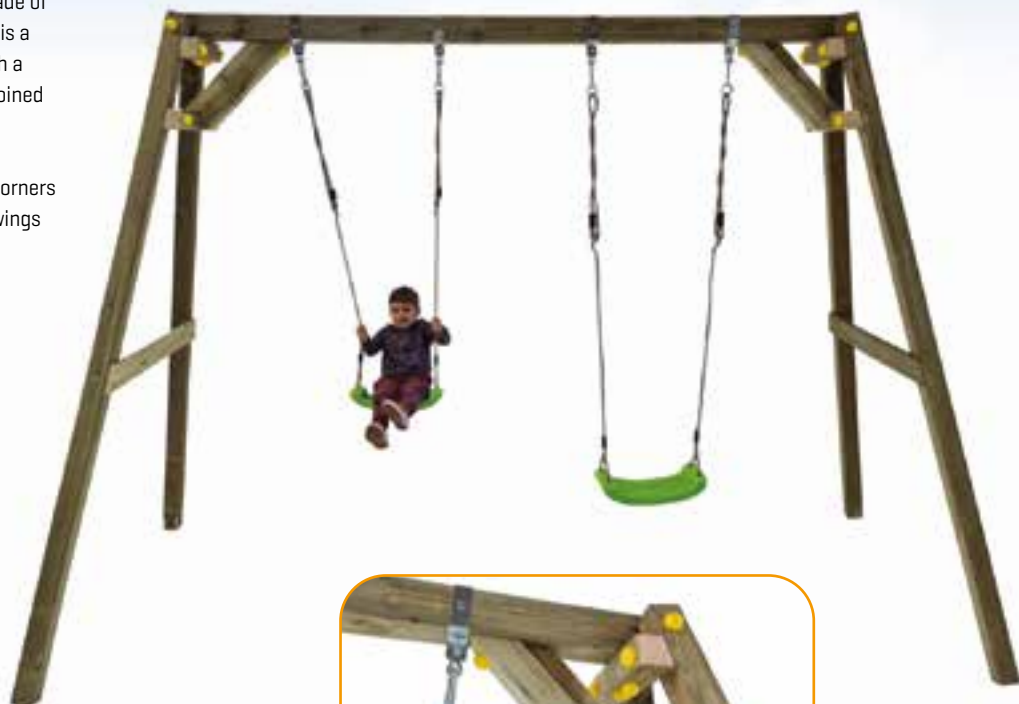

The maximum weight of the seat user individual of the swing are **70 kg**



250 x 27 x 18 cm



50 x 30 x 40 cm



Xylo single



Ref: MA700038



Imagine the little ones playing with this swing: WATCH IT HERE!



Xylo with baby seat

- Includes 3 seats:
- Two flat seats
 - A baby seat

Ref: MA700039





KAI

The classic double swing made of square wood, with excellent quality-price ratio.

This model, apart from the two plastic seats, also has a UFO seat for swinging.

- Measurements: 3.20 m. [length] x 1.90 m. [width] x 2.20 m. [height]
- 2 plastic seats and ropes.
- 1 UFO seat
- Metal joining pieces, anchors and screws.
- Posts: 68x68 mm thick
- Crossbar: 88x88 mm thick

Ref: MA700056

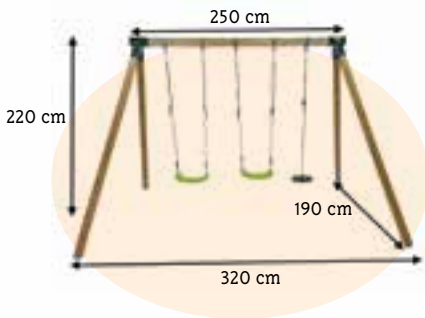

The maximum weight of the seat user individual of the swing are **70 kg**

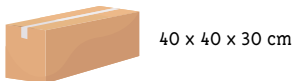
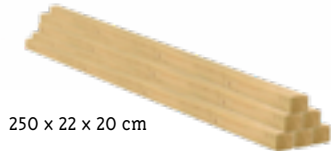



YUA

The YUA swing offers extra fun because it includes a rope ladder to go up and down and also has two flat seats

- Dimensions: 320 cm [length] x 194 cm [width] x 221 cm [height].
- 2 plastic seats and ropes.
- 1 rope ladder
- Metal connecting pieces, anchors and screws.
- Posts: 68x68 mm thick
- Crossbar: 88x88 mm thick

3-12
years

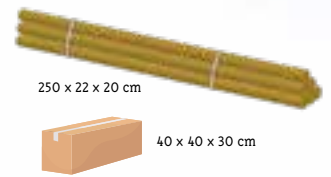
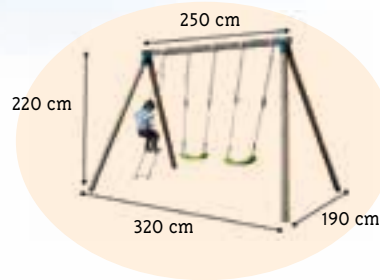

Ref: MA700057



The maximum
weight of the seat
user individual of
the swing are
70 kg



3-12 years

KARAI JUNIOR

The Karai Junior swing is strong and beautiful. It is made of square wood.

One of the advantages of square wood is that it has fewer cracks, because it is a wood that is cut from the center of the tree. The swing includes wooden posts, the plastic seats, the hooks, the set of green corners and the set of anchors.

Dimensions: 2.80 m. [length] x 2.08 m. [width] x 2.18 m. [height]

Crossbar dimensions: 88 x 88 mm

Leg thickness: 68 x 68 mm

Residential use.

Ref: MA700030

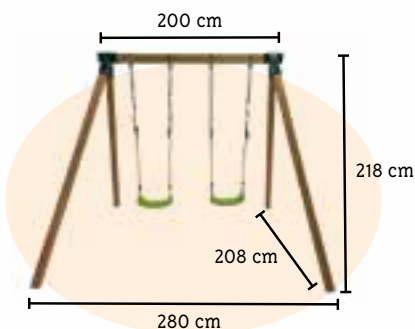

220 x 22 x 20 cm



40 x 40 x 30 cm



The maximum weight of the seat user individual of the swing are **70 kg**

Karai Junior with baby seat

Includes 3 seats:

- Two flat seats
- A baby seat



KARAI. With baby seat:

Ref: MA700031



NORI

3-12
years

Triple the fun with the NORI swing!

This model includes 3 flat seats so that 3 children can swing at the same time.

It is made of very resistant square wood.

- Measurements: 3.40 m. [length] x 1.90 m. [width] x 2.20 m. [height]
- 3 plastic seats and ropes.
- Metal connecting pieces, anchors and screws.
- The length of the crossbar is 270 cm.
- Posts: 68x68 mm thick
- Crossbar: 88x88 mm thick

Ref: MA700059

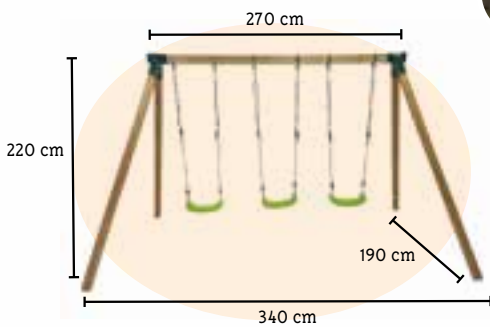

Nori with a baby seat

Triple base structure with baby seat.

Includes:

- 3 plastic seats and strings
- 1 baby seat and strings
- 1 set of corners and anchors

Ref: MA700060

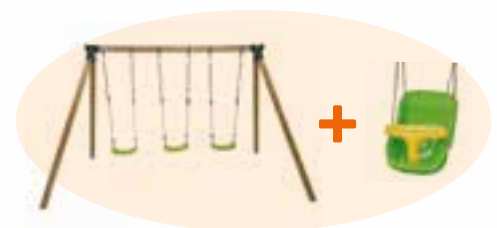

The maximum weight of the seat user individual of the swing are
70 kg

Nori with seat "face to face"

- 2 flat seats
- 1 double seat "face to face"

Ref: MA700061



3-12
years

AKINA

The classic double swing made of square wood, with excellent qualityprice ratio.

The AKINA swing combines a plastic seat with a "nest" seat

- Measurements: 3.40 m. [length] x 1.90 m x 2.20 m. [height].
- 1 plastic and rope seat.
- 1 "nest" seat
- Metal connecting parts, anchor screws.
- Posts: 68x68 mm thick
- Crossbar: 88x88 mm thick

Ref: MA700058



The maximum weight of the seat user individual of the swing are **70 kg**

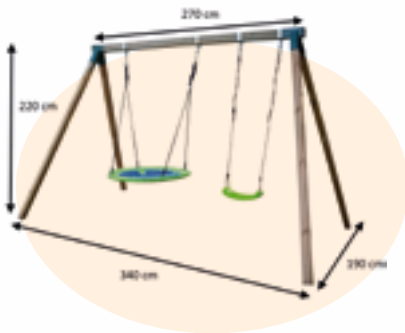

270 x 20 x 10 cm



50 x 40 x 30 cm



KARAI ADULTS

The KARAI swing is very strong and durable and is made of 88x88 cm thick square wood, making it a structure that also allows adults to swing on.

One of the advantages of square wood is that it has fewer cracks, because it is a wood that is cut from the center of the tree.

- The swing includes the wood, two rubber seats with synthetic or rubber ropes with chains, hooks, green corner set and anchor set. 3.40 m
- Dimensions: 2.15 m [height] x 2.80 m [width] x 3.40 m [length]
- Crossbar dimensions: 2.50 m [length]
- Stick thickness: 88x88 cm
- Residential use

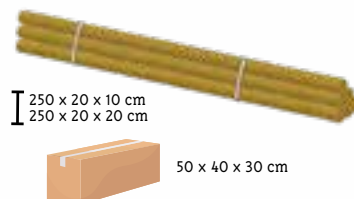
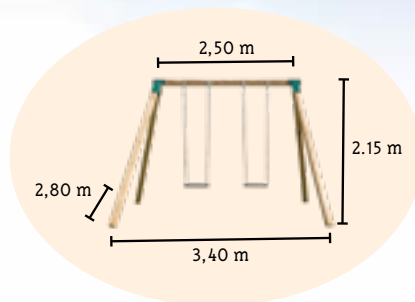

Karai - STRINGS

Ref: MA700068



The Karai Deluxe Single Swing on video.
FIND OUT HERE!



The maximum weight of the seat user individual of the swing are **95 kg**

Karai Deluxe single



Masgames Karai DELUXE INDIVIDUAL ADULTS - SWINGS

Ref: MA700068

Masgames Karai DELUXE INDIVIDUAL ADULTS - CHAINS

Ref: MA700069

Karai adults with chain seats

The classic swing with a rubber seat and chains.

Includes:

- 2 rubber seats with chains.



The maximum weight of the seat user individual of the swing are **110 kg**

Seats with CHAINS:

Ref: MA700069

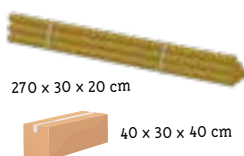

SWING ACCESSORIES

Red baby seat
Ref: MA400929



Green baby seat
Ref: MA400925



UFO seat
Ref: MA415121



Metal rings
Ref: MA400826



Wooden rings
Ref: MA400828



Trapeze
Ref: MA400825



Climbing rope
Ref: MA400827



Rope ladder 2 anchors
Ref: MA32040



Rope ladder one anchor
Ref: MA32430



Indoor hook
Ref: MA400835



Round swing hook 100 mm
Ref: MA81035



Squared swing hook 90x90 mm
Ref: MA081036



14 cm long swing hook
Ref: MA400833



Flat anchor
Ref: MA400834



Long anchor
Ref: MA400832



We have a nice range of accessories specially designed for domestic playgrounds and MASGAMES swings.

Face to face seat for round wood
Ref: MA400025



Face to face seat for squared wood
Ref: MA400026



Nest seat Kiwi
Ref: MA400900

Red plastic seat
Ref: MA400875



Blue plastic seat
Ref: MA400876



Apple green plastic seat
Ref: MA400878



Dark green plastic seat
Ref: MA400879



Wooden swing seat
Ref: MA400850



Rubber and ropes swing seat
Ref: MA400822



Baby seat Deluxe blue
Ref: MA400301



Baby seat Deluxe Green and yellow
Ref: MA400306



Baby seat Premium Orange
Ref: MA400302



WOODEN PLAYGROUNDS

NEW 2025

Children's playground **TIBET**

TIBET playground is a fun and adventure centre perfect for ages 3 and up to 9 or even 10.

This playground offers three very different play areas. On the one hand, there is a two-seat swing that allows for endless combinations: baby seats, nest seats or any acrobatic accessory. Next to the swing, the inclined climbing wall is the access to the platform raised to 90 cm. But as the TIBET playground can only be called that if it is full of adventure, the opposite side of the climbing wall is a wooden framework to test the little adventurers.

And from its platform, the 175 cm long slide ramp will return them to the ground. With a design that will blend perfectly into your garden and suitable for compact and medium-sized spaces, it is the perfect choice for great adventurers who dream of reaching the highest peaks ever imagined.

Also option without slide.

Ref. MA700098



Explore
TIBET park!
WATCH IT HERE!



WOODEN PLAYGROUNDS

Children's playground MILOS

2-6
years

The MILOS structure is a Children's playground with an excellent quality-price ratio.

- It consists of a platform with a slide ramp and a double swing with plastic seats and synthetic ropes.
- Includes a green slide ramp, 2 green plastic seats and ropes, 1 set of corners and flat anchors.
- The height of the first floor of the platform is 0,90 m.
- The round wooden posts have a measurement of 80 mm and 100 mm [diameter].
- The maximum user weight of the single seat is 70 kg.

Ref: MA700005

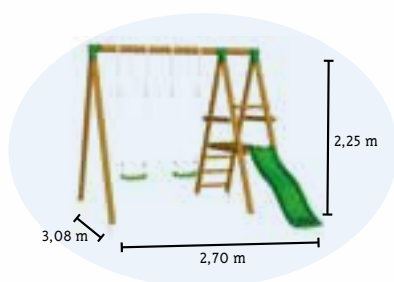

120 x 20 x 20 cm
250 x 20 x 20 cm
270 x 20 x 20 cm
180 x 40 x 20 cm
40 x 40 x 30 cm

Milos With baby seat

Includes 3 seats:

- Two flat seats
- A baby seat

Ref: MA700005-B





Children's playground TIMBU

3-12
years

The Timbu Playground is a park that offers triple fun!

At the Timbu Children's playground, children can swing on the swing with two individual seats, climb the climbing wall and climb the rope ladder.

It is made of pine wood treated for exterior use and protected with autoclave IV.

The TIMBU playground is approved for the garden of a private home

Includes:

- Double swing structure.
- Two plastic seats with ropes synthetic.
- Climbing ramp with plastic stones synthetic.
- Synthetic rope ladder

Ref: MA700500



Children's playground MAUNA LOA

ROUND WOOD

The MAUNA LOA series of playpens is a wooden structure with an excellent quality-price ratio. It is made of quality wood, treated for outdoor use and is dark in colour. They are made for private use. A fun children's playground with a slide.

- Measurements: 2.97 m. [length] x 3.39 m. [width] x 2.28 m. [height].
- They are suitable for children from 3 to 12 years old. • The round wooden poles have a 80mm and 100mm [diameter] measurements.
- The slide ramp is made of injected HDPE plastic.
- The maximum weight of the seat user individual of the swing are 70 kg.

120 x 20 x 20 cm
230 x 20 x 20 cm
270 x 20 x 20 cm
235 x 45 x 30 cm



Ref: MA700011



The maximum weight of the seat user individual of the swing are **70 kg**

A hose can be attached to the ramp to make the water slide.

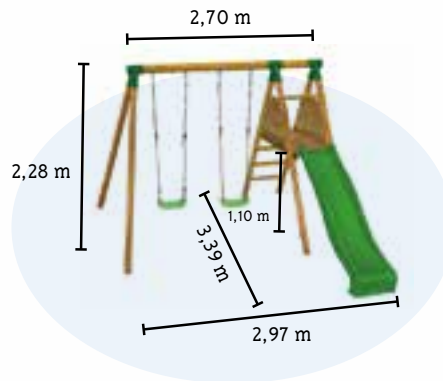
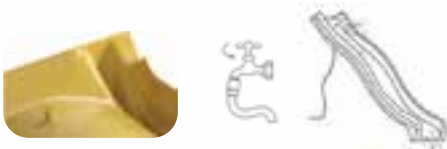

Mauna Loa With baby seat

- Includes 3 seats:
- Two flat seats
 - A baby seat

Ref: MA700011-B



We teach you the
Mauna Loa Park
and all its details.
WATCH IT HERE!





MAUNA LOA

and their combinations

WITH CLIMBING WALL



ACADEMY WITH CLIMBING WALL



ACADEMY



FACE TO FACE





Children's playground **DOLOMITES** Challenger

3-12
years

The Dolomites is a Children's playground with a platform that can be climbed on from three sides: on one side there is a climbing wall with climbing stones, on the opposite side there is a climbing net and on the side of the structure there is a wooden staircase with the rungs specially placed in an irregular manner. It also includes a swing frame with two seats. Approved for private use

Includes:

- Dolomites structure with platform
- Swing structure
- Two plastic seats with synthetic ropes
- Anchors and hardware
- Swing crossbar measurement: 2.40 mts.
- Measurements: 326 cm long x 257 cm wide x 210 cm high
- Platform height: 133 cm
- Total height: 2.18 mts.



Ref: MA800700



Children's playground **SIBERIA** ADVENTURE

The Siberia Adventure park is similar to the previous Dolomitas Challenger, although the rope network has been replaced by wooden crossbars inclined at different positions. In addition, the upper platform is flat and has protection on both sides by a wooden wall.

The Siberia Adventure park is available in L or XL versions for more or less doses of adventure and is also manufactured without the two legs so it can be attached to any Masgames wooden tower.

SIBERIA L

Ref: MA800800

SIBERIA XL

Ref: MA800850



1-3
years

Children's playground **KILAUEA**

Playground designed for small children between 1-3 years old. It is a small-sized playground ideal for small spaces.

Children will enjoy a playground with an elevated playhouse and a swing with a baby seat. They can climb up the easily accessible stairs and slide down the slide ramp.

Ref: MA700001



Children's playground

LIGNUM

3-12
years



Wooden playground with double swing and platform with slide. The MASGAMES LIGNUM playground is made up of a XYLO double swing and a MOLA platform with slide. A strong, high and safe playground with the best quality-price ratio.

The MASGAMES LIGNUM playground is made of square wood treated for outdoor use.

Unlike other playgrounds or swings, this structure does not need metal corners to hold the crossbar with the legs.

Thanks to an innovative design, the structure is much more secure and with less movement than parks that have metal corners.

The assembly, on the other hand, takes a little longer, although it is still easy for families to set up the park without problems

The LIGNUM playground structure includes:

- 2 flat plastic seats and ropes
- Anchors for soil, sand or grass and screws
- 230cm long slide ramp

The dimensions of the MASGAMES LIGNUM playground are as follows:

Measurements: 335 cm [length] x 285 cm [width to the end of the slide] x 220 cm [height]

The square wooden posts measure 68x68 mm at the legs and 88x88 mm at the top post. The height of the first tier of the platform is 1.20 m. The slide ramp is 2.32 m long. The slide ramp is made of HDPE which is highly resistant to corrosion and therefore suitable for outdoor use. In summer, a hose can be connected to the ramp so that water can flow down the ramp. This is a combination that offers many possibilities for fun for children.



The maximum user weight of the single swing seat is 70 kg.

Ref: MA700066



Lignum

With baby seat

Includes 3 seats:

- Two flat seats
- A baby seat

Ref: MA700067

Children's playground MAUNA LOA

SQUARE WOOD

3-12
years

The MAUNA LOA Children's playground from SQUARE WOOD has a platform with a slide that can be climbed up using a rear ladder and then glided down the slide ramp. It also includes a double swing with two seats.

It is made from wood treated for outdoor use, cut in a square shape, which makes it stronger and more resistant and has fewer cracks than round wood.

The slide has the option of attaching a water hose.

The Mauna Loa Children's playground Includes:

- Double swing structure.
- Two plastic seats with synthetic ropes.
- Wooden platform with ladder.
- 2.32 m slide ramp.
- Set of corners, anchors and screws.



Ref: MA700080

Dimensions: 2650 mm (length) x 3250 mm (width to the end of the slide) x 2300 mm (height).

- The legs are 68x68 mm and the upper crossbar is 88x88 mm.
- The height of the first floor of the platform is 1.20 m.
- The slide ramp is 2.32 m long.



The slide ramp is made of HDPE, which is highly resistant to corrosion and therefore suitable for outdoor use. In summer, a hose can be connected to this ramp so that water can flow down the ramp. This combination therefore offers many possibilities for fun for children.

Mauna Loa With baby seat

Includes 3 seats:

- Two flat seats
- A baby seat

Ref: MA700081



Children's playground

LOOKOUT

The Lookout playground is a multi-purpose playground. It consists of a playhouse and a tower with a slide next to it. The playhouse has a window on one side, a half-height door on the opposite side, a railing on the side and finally, on the side that is connected to the tower, it is open so that the tower can be accessed.

The Lookout Park is available in two versions:

- Lookout S Park has a platform with a slide at a height of 60 cm. The tower has a height of 2.49 m
- The Lookout M playground has a platform with a slide at a height of 90 cm. The tower has a height of 2.79 m

The house is the same in both versions and has dimensions of 161.6 cm [length] x 130 cm [width] x 155 cm [height].

The dimensions of Lookout Park are:

203.8cm [L] x 161.6cm [W] x 279cm [H]

The height of the slide platform is 90 cm

The slide ramp is 144 cm long

You must leave 2 meters around the safety zone.



1-4
years

LOOK-OUT S

Ref: MA801821

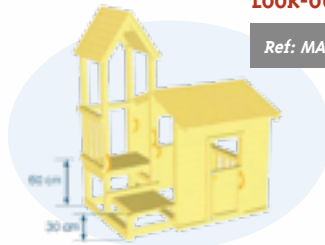

2-6
years

LOOK-OUT M

Ref: MA801801



ACCESSORIES (not included)



CHALLENGER Ref. MA803701



Individual swing I - Ref. MA700140



Double supported swing I - Ref. MA700150

Children's playground CASCADE

The tower is irresistible and will instantly captivate the youngest adventurers with its charming appearance. Easily accessible and with two platforms, the Cascade tower is full of fun.

The Tower has two connected platforms and a sloped ramp entrance, making the tower more easily accessible for all ages.

Approved for private use.

Includes:

- Cascade Tower with Roof
- Slide for heights of 0.90 / 1.20 m
- Side platform
- Access ramp
- Sandbox [without sand]
- Anchors



CASCADE M

Ref: MA801521



CASCADE L

Ref: MA801501



ACCESSORIES (not included)



CHALLENGER Ref. MA803701



Individual swing I - Ref. MA700140



Double supported swing I - Ref. MA700150



Children's playground CARLIT

3-9
years

The Carlit playpen offers a wide range of variants. It is available in M and L heights [house at 90 or 120 meters high].

The M version includes a double swing, while the L version can be with or without a swing and with or without a climbing wall!



CARLIT M

Ref: MA700250

M

L



Carlit Park is ideal for spaces reduced. Do you like it? IN THIS VIDEO WE SHOW YOU MORE!!



CARLIT CANVA

The Carlit Children's playground with a canvas roof is also available in M and L heights [house at 90 or 120 height] and its L version also allows you to add a climbing wall and do without the double swing if you don't have enough space.

M

L

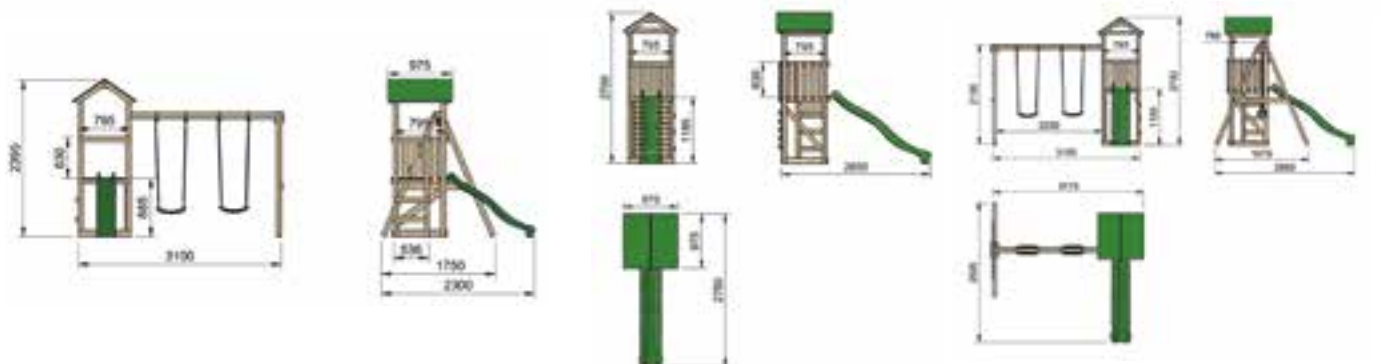

Children's playground

TAGA

3-12
years

TAGA playground is made of pine wood treated for outdoor use and is very robust and durable. It has an elevated playhouse that children can access via a ladder and a side balcony where they can slide down the slide.

TAGA 1

This playground is available in 2 versions:

MA700300

> TAGA playground WITHOUT climbing wall.

MA700360

> TAGA playground with climbing wall

One of the advantages of this park is that depending on the area where the slide has to be installed, it can be placed at the front or on the side of the park.

Measurements with the slide arranged at the front: 1.59 m (width) x 2.8 m (height) x 3.59 m (length).

Measurements with the slide arranged sideways: 1.59 m (width) x 2.8 m (height) x 4 m (length).

This playground is intended for private use only.

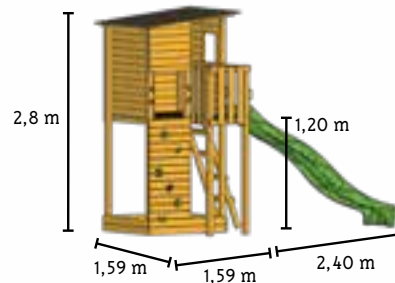

Ref: MA700360

ACCESSORIES (not included)



ADVENTURE I Ref. MA813701



Individual swing I - Ref. MA700140



Double supported swing I - Ref. MA700150



Children's playground KIOSK

3-12
years

The KIOSK tower is a playpen that offers very good value for money.

This playground is made of 70mm square wood and has an excellent finish.

Approved for private use.

Available in two heights

This spectacular structure **includes:**

- 1 house with raised roof
- 1 climbing ladder
- 1 sandbox (without sand)
- 1 slide
- Anchors



ACCESSORIES (not included)



CHALLENGER/CHALLENGER XL
Ref. MA803701/801



Individual swing I - Ref. MA700140
Individual swing XL - Ref. MA700141



SWING
swing I swing I - Ref. MA803501
swing XL swing XL - Ref. MA803601

Children's playground

TIBIDABO

3-12
years

Fun elevated playhouse with a slide ramp. At the base of the tower there is a sandbox [without sand] so children can play.

Made of sturdy square wood treated for outdoor use.

Tower Measurements:

1,19 m (ancho) x 2,87 m (alto) x 1,35 m (largo)

The square wooden posts have a measurement of 80 mm.

Approved for the garden of a private home

TIBIDABO L

Ref: MA700220

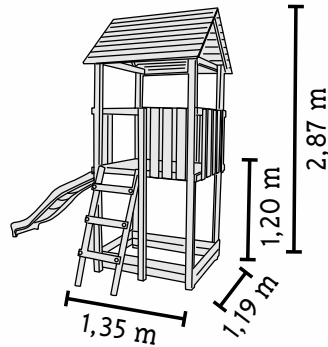

TIBIDABO CANVA

This version has a canvas roof and is very weather resistant.

It is also better value for money

TIBIDABO CANVAS L

Ref: MA700219



ACCESSORIES (not included)



ADVENTURE L Ref. MA813701



Individual swing L - Ref. MA700140



Double supported swing L- Ref. MA700150

3-12
years

TIBIDABO

with playhouse below

With this playground, children will have double the fun by climbing the tower and sliding down the slide or playing inside the playhouse that has a hinged door and a fixed window. Made of sturdy square wood and treated for outdoor use.

Tower Measurements:

1.19 m [width] x 2.87 m [height] x 1.35 m [length]

The square wooden posts have a measurement of 80 mm.

Approved for the garden of a private home.

TIBIDABO I with little house

Ref: MA700230

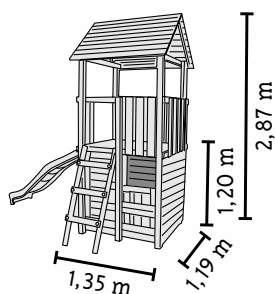

TIBIDABO XL with little house

Ref: MA700245

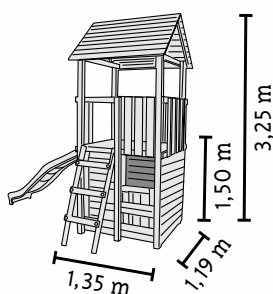

TIBIDABO CANVA

with playhouse below

This version has a canvas roof and is very weather resistant.

It is also better value for money

TIBIDABO CANVAS I with little house

Ref: MA700229



ACCESSORIES (not included)



ADVENTURE I Ref. MA813701



Individual swing I - Ref. MA700140



Double supported swing I - Ref. MA700150

3-12
years

TIBIDABO

with climbing wall

The TIBIDABO tower is a tower from the MASGAMES brand that offers a lot of fun and a very good quality-price ratio. Kids will love it!

This spectacular structure includes:

- 1 house with raised roof
- 1 wooden staircase
- 1 climbing wall
- 1 slide with water connection
- 1 set of anchors
- Measurements: 2.87 m [height] x 1.19 m [width] x 1.35 m [length]
- The length of the tower with the slide is 3.03 m
- The height of the first floor of the house is 1.20 m

TIBIDABO I

Ref: MA700215

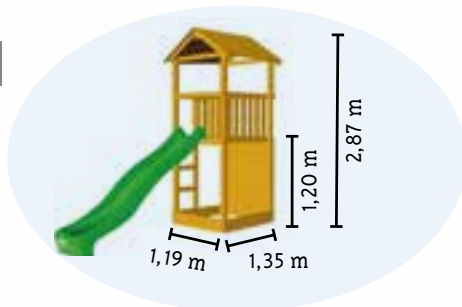

TIBIDABO CANVA

with climbing wall

This version has a canvas roof and is very weather resistant. It is also better value for money.

TIBIDABO with climbing ramp

Ref: MA700202



ACCESSORIES (not included)



ADVENTURE I Ref. MA813701



Individual swing I - Ref. MA700140



Double supported swing I - Ref. MA700150



3-12
years

TIBIDABO

with climbing wall and playhouse



This is the most complete version of the TIBIDABO tower because at the bottom of the tower there is a little house with a door and window. Children can climb up the tower using the wooden ladder or the climbing wall, and once at the top they can slide down the slide ramp. Made of sturdy square wood and treated for outdoor use

Tower Measurements:
1,19 m [ancho] x 2,87 m [alto]
x 1,35 m [largo]

Square wooden posts
have a measurement of
80 mm. 1.35 m

Approved for the garden of
a private home.

TIBIDABO
with wall and playhouse

Ref: MA700210

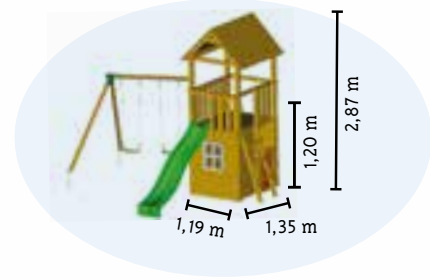

TIBIDABO CANVA

with climbing wall and playhouse

This version has a canvas roof and is very weather resistant.
It is also better value for money.

TIBIDABO con House y Ramp escalada

Ref: MA700239



ACCESSORIES (not included)



ADVENTURE L Ref. MA813701



Individual swing L - Ref. MA700140



Double supported swing L - Ref. MA700150

3-12 years

Children's playground LOLLIPOP

The Lollipop Playground combines the Lollipop XL playhouse with a spectacular elevated structure and a staircase with railing for easy access. In addition, the large L-shaped balcony, the climbing wall, the slide and the sandbox make this an incredible play space!

This playground is made of wood treated for outdoor use (autoclave level IV) from renewable European forests.

This playground is available in 3 colours, pink, green and blue, and will have the matching slide ramp.

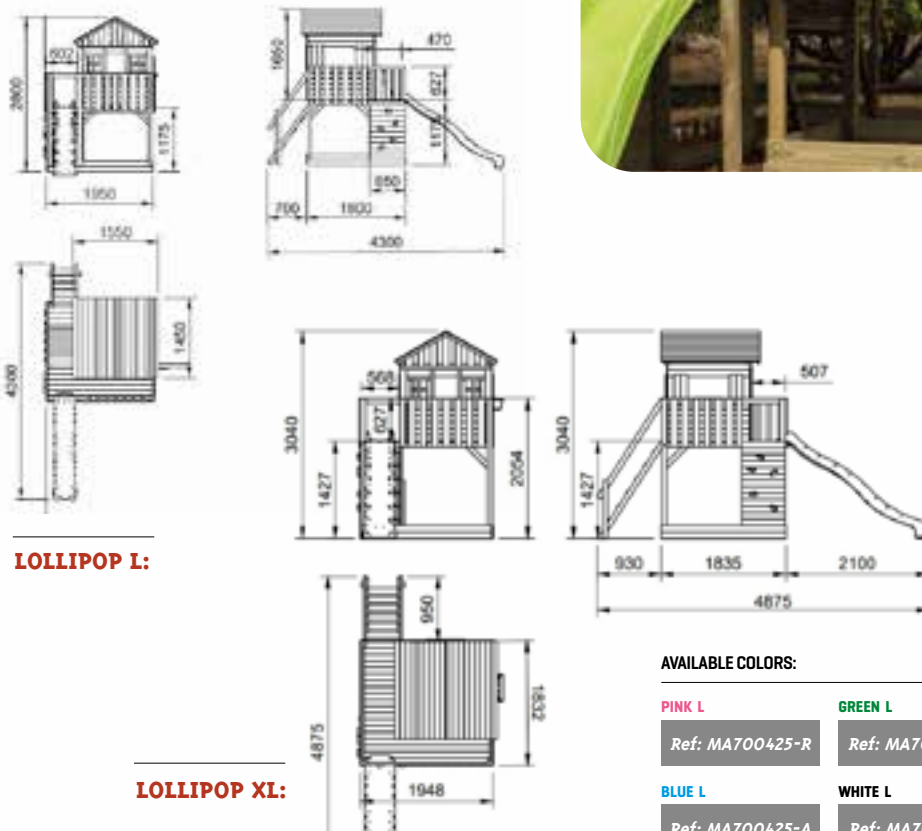

AVAILABLE COLORS:

PINK L

Ref: MA700425-R

GREEN L

Ref: MA700425-V

PINK XL

Ref: MA700428-R

GREEN XL

Ref: MA700428-V

BLUE L

Ref: MA700425-A

WHITE L

Ref: MA700425-B

BLUE XL

Ref: MA700428-A

WHITE XL

Ref: MA700428-B

ACCESSORIES (not included)



ADVENTURE I Ref. MA813701



Individual swing I - Ref. MA700140



Double supported swing I - Ref. MA700150



Children's playground

NAUTILUS WITH CLIMBING WALL

The NAUTILUS playground is a boat-shaped playground where children can let their imagination run wild, turning into little sailors or terrifying pirates for a moment. Kids will love it!

The tower can be accessed via the wooden stairs and once on the platform, children can play with the rudder, imagining that they are driving a boat, or slide down the slide ramp. At the bottom there is a sandpit in the shape of a boat with a bench to sit on.

This version includes a climbing wall and children can climb the tower on this wall. However, this model does not allow for the inclusion of a swing or the @challenger.

This spectacular structure includes:

- 1 raised house with a sloping roof
- 1 sandbox (without sand) in the shape of a boat
- 1 wooden ladder
- 1 climbing wall with climbing stones
- 1 slide ramp with water connection in lime green
- 1 boat wheel
- 1 set of anchors

Tower dimensions: 2.75 m (height) x 2.70 m (width) with the slide ramp x 2.75 m (length)

The height of the first floor of the little house is 1.20 m.

Approved for private use.

NAUTILUS I

Ref: MA700330

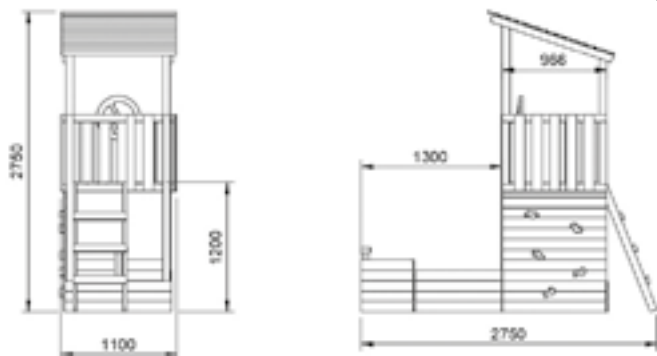
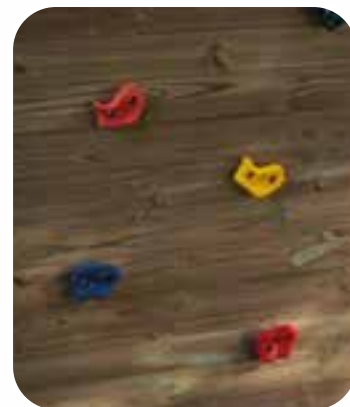

Children's playground NAUTILUS

The new NAUTILUS playground is a boat-shaped playground where children can let their imagination run wild, turning into little sailors or terrifying pirates for a moment. Children will love it! The tower can be accessed via the wooden stairs and once on the platform, children can play with the rudder, imagining that they are driving a boat, or slide down the ramp of the slide. At the bottom there is a boat-shaped sandbox with a bench to sit on.

This version does not include the climbing wall but children will have a railing at the top and the sandbox walls will be completely open. This version allows for the inclusion of a single or double swing and the @challenger

This spectacular structure includes:

- 1 raised house with a sloping roof
- 1 sandbox (without sand) in the shape of a boat
- 1 wooden ladder
- 1 climbing wall (depending on version)
- 1 slide wall with water connection in lime green
- 1 ship's wheel
- 1 set of anchors



Tower dimensions: 2.75 m (height) x 2.70 m (width) with the slide ramp x 2.75 m (length)

The height of the first floor of the little house is 1.20 m.

Approved for private use.

NAUTILUS I

Ref: MA700325

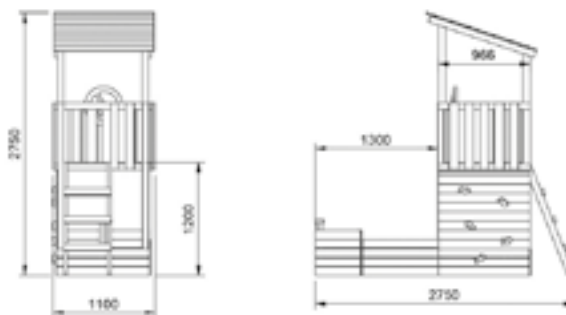

3-12
years

ACCESSORIES (not included)



ADVENTURE I Ref. MA813701



Individual swing I - Ref. MA700140



Double supported swing I - Ref. MA700150



 3-12
years

Children's playground **BELVEDERE**

The BELVEDERE tower is a tower that offers very good value for money.

This playground is made of 80mm square wood and has an excellent finish.

Children's playground approved for private use. Available in two heights.

This spectacular structure includes:

- 1 house with raised roof
- 1 climbing ladder
- 1 climbing ramp (includes 5 climbing stones)
- 1 sandbox (without sand)
- 1 slide
- Anchors

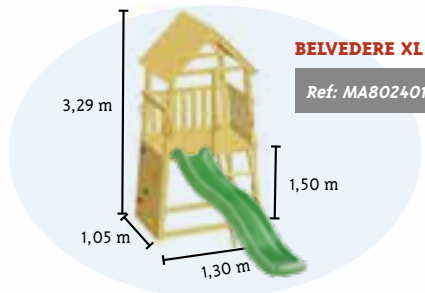
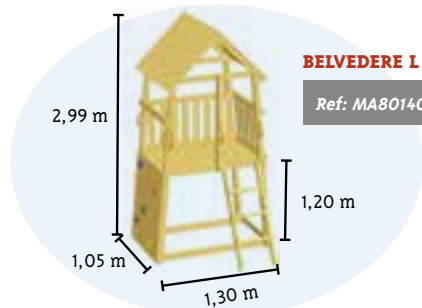

ACCESSORIES (not included)



CHALLENGER/CHALLENGER XL
Ref. MA803701/801



Individual swing L - Ref. MA700140
Individual swing XL - Ref. MA700141



SWING
Swing @swing L - Ref. MA803501
Swing @swing XL - Ref. MA803601

3-12
years

Children's playground BEACH HUT

The BEACH HUT tower is a playpen similar to the typical lifeguard huts on the beach. And the best thing is that it offers very good value for money.

This charming beach hut features a nice front balcony that will provide hours of fun. With a large sandbox like their own private beach, kids can build the biggest sand castles they've ever imagined. It also includes an entrance staircase at the back and an additional entrance opening at the front, perfect for another addon module or to include the rope ladder [optional].

Children's playground approved for private use. Available in two heights.

This spectacular structure includes:

- 1 house with raised roof
- 1 climbing ladder [rear]
- 1 sandbox (without sand)
- 1 slide
- Anchors



ACCESSORIES (not included)



CHALLENGER/CHALLENGER XL
Ref. MA803701/801



Individual swing I - Ref. MA700140
Individual swing XL - Ref. MA700141



Double supported swing I - Ref. MA700150
Double supported swing XL - Ref. MA700151



NET Ref. BR803301

BEACH HUT L

Ref: MA801301

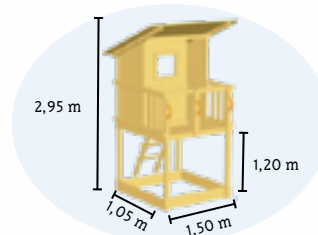

BEACH HUT XL

Ref: MA802301

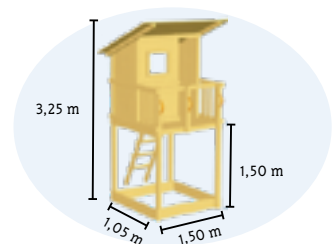



Children's playground

PAGODA

3-12
years

This tower provides a wide range of possibilities for play. The integrated balcony can be used as a viewing tower and really increases the play value of this spacious tower. The sandbox below offers ample space for digging and building sand castles.

The tower is reminiscent of an ancient Oriental temple, the unique look of the Pagoda Tower is a guarantee of hours of discovery and adventure.

The Pagoda Tower has two entrance openings, one at the back (with a sloping staircase) and one at the front (vertical staircase). The front entrance can also be used to add an extra module to the Pagoda, or even a second slide.

Approved for private use.

Includes:

- Tower
- Slide ramp
- Sandbox (without sand)
- Vertical ladder
- Leaning staircase (later)
- Anchors and screws

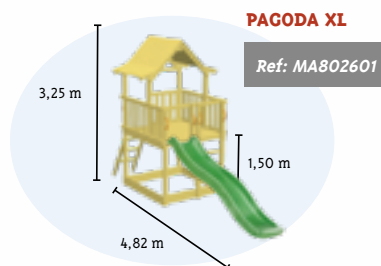
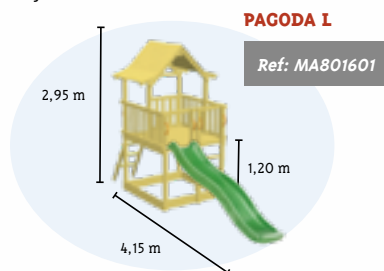

ACCESSORIES (not included)



CHALLENGER/CHALLENGER XL
Ref. MA803701/801



Individual swing I - Ref. MA700140
Individual swing XL - Ref. MA700141



Double supported swing I - Ref. MA700150
Double supported swing XL - Ref. MA700151

3-12
years

Children's playground CROSSFIT

This multi-game playground offers multiple activities so that children can have fun and play sports at the same time.

Versions:

- With 3-meter slide ramp.
- With a fireman's pole.

Approved for private use.

Includes:

- Wooden structure
- Monkey bridge
- 2 fixed bars
- Climbing wall
- Vertical ladder wood
- Rope wall
- Walkway/bench wood
- Slide ramp or Fireman's stick
[depending on model]

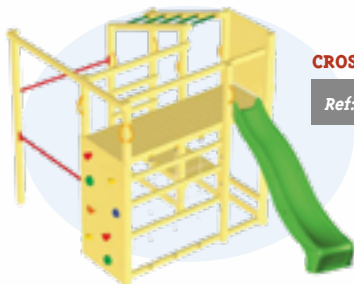

CROSSFIT XL

Ref: MA802901

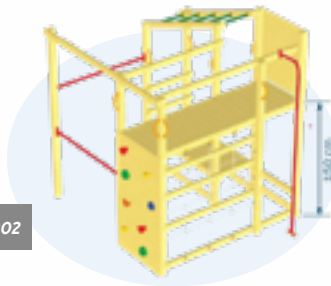

CROSSFIT XL

Ref: MA802902

ACCESSORIES (not included)



CHALLENGER XL Ref. MA803801



Individual swing XL - Ref. MA700141



Double supported swing XL - Ref. MA700151



Children's playground

TEIDE

3-12
years

The TEIDE playground from the MASGAMES brand is a strong and sturdy square wooden tower, ideal for children to play on.

The TEIDE playground consists of a raised wooden house, which is accessed by climbing a ladder and can be descended by the slide ramp. At the base there is a sandbox that can be filled with sand for playing and it also includes a climbing wall.

The park includes:

- Wooden structure.
- Green slide ramp made of HDPE plastic.
- Anchors for fixing to the ground or grass.
- Climbing stones.
- Bolt caps, handles and mounting instructions.

TEIDE XL

Ref: MA700100

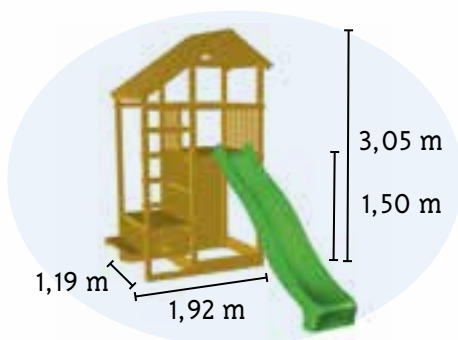

ACCESSORIES (not included)

With swing individual

XL Supported Swing

Ref: MA700141



With swing double

Base structure with double swing.

Ref: MA700151



With ladder of monkey

Base structure with mono bridge.

Ref: MA700102



With double swing and monkey ladder

Base structure with single bridge and double swing

Ref: MA700103



Children's playground

PENTHOUSE

3-12
years

The PENTHOUSE tower is the largest and most complete tower. It offers excellent value for money.

This playground is made of square wood measuring 70 mm and has an excellent finish. Approved for private use.

Includes:

- 1 house with raised roof
- 1 wooden staircase
- 1 balcony with climbing ramp
- 1 sandbox (without sand)
- 1 slide
- Anchors, screws, bolts

PENTHOUSE XL

Ref: MA802201



Dimensions: 3.38 m [height] x 2.00 m [width] x 1.99 m [length]. The square wooden posts measure 70 mm. The height of the first floor of the cottage is 1.50 m.

The height of the balcony is 1.20 m.

Accessories such as rope ladder, bell, periscope, telescope, steering wheel, etc. are not included but can be purchased separately.

ACCESSORIES (not included)



CHALLENGER XL Ref. MA803801



Individual swing XL - Ref. MA700141



Double supported swing XL - Ref. MA700151



Children's playground **SYRACUSE**

NEW 2025

The MASGAMES SYRACUSE XL playground is a versatile and durable playground, ideal for private gardens with enough space to install this large outdoor play centre.

It includes a wooden tower with a little house raised to a height of 142.5 cm, an L-shaped balcony with a railing, a slide ramp and a climbing wall, as well as numerous play areas at different heights which, in turn, provide access to the top. Made from level IV autoclave-treated wood, it comes from sustainable forests in northern Europe.

Ref. MA700440



Main features:

- At the top you will find a Lollipop House XL with a roof, flower pot and windowsill. The house alone is over 160 cm high.
- HDPE slide ramp almost 3 metres long with the possibility of connecting a water hose to it and turning it into a water slide: a “freaky thing” for the summer!
- Climbing wall with coloured holds to access the 120cm high platform.
- Small additional platform at 60 cm height.
- Large sandbox at the base for games and greater stability.
- Ladder with handrail for safe access.

Park measurements**[without swings or Adventure module]:**

- Dimensions: 486.5 x 273 x 304 cm.
- Safety area: 685 x 520 cm.
- Maximum platform height: 142.5 cm

MULTIPLY THE FUN BY 10X!:

Add a structure with one or two swings or the Adventure module, which, in addition to a double swing, includes a climbing wall and zig-zag climbing frame.

“A complete play space to encourage fun, activity and imagination outdoors.”





Children's playground

PALAZZO

3-12
years

Spectacular tower with several integrated elements, it is so big that children will never get bored.

It has a large platform with a balcony on one side and is connected to a little house for hiding.

Below it houses a huge sandbox and a resting area with a bench that is also a trunk for storing toys.

The tower can be accessed via a climbing wall, a fixed ladder or an inclined ladder.

Approved for private use.

Includes:

- 1 Tower with raised roof
- 1 Elevated house with roof, doors and windows
- 3-meter slide ramp.
- 1 wooden inclined ladder
- 1 wooden vertical ladder
- 1 wooden platform with box
- 1 sandbox (without sand)
- Anchors and screws



PALAZZO XL

Ref: MA802701

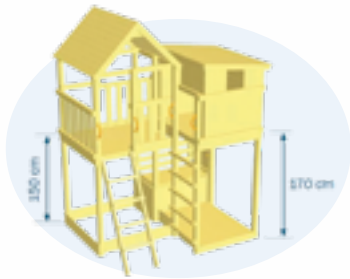

- The Palazzo wooden tower has the following dimensions: 4.53 m (length) x 2.47 m (width) x 3.38 m (height)
- The dimensions of the cabin are: 143 cm (length) x 124 cm (width) x 100 cm (lowest height)
- The height of the slide platform is 1.50 m
- The height of the playhouse platform is 1.70 m
- The slide ramp is 3 m long
- You must leave 2 meters around the safety zone.

ACCESSORIES (not included)



CHALLENGER XL Ref. MA803801



Individual swing XL - Ref. MA700141



Double supported swing XL - Ref. MA700151

3-12
years

Children's playground

ATLANTIC



The ATLANTIC children's park is a spectacular structure that combines the Tibidabo Tower with an integrated playhouse with the Nautilus Tower, the two towers connected by an elevated bridge.

Tibidabo Tower:

- Elevated structure
- Little house at the bottom of the tower with door and window
- Slide ramp
- Anchors, screws and plugs

Elevated bridge

- Wooden bridge structure

Nautilus Tower

- 1 raised house with a sloping roof
- 1 sandbox [without sand] in the shape of a boat
- 1 wooden ladder
- 1 climbing wall with climbing stones
- 1 ship's wheel
- Anchors, screws and plugs

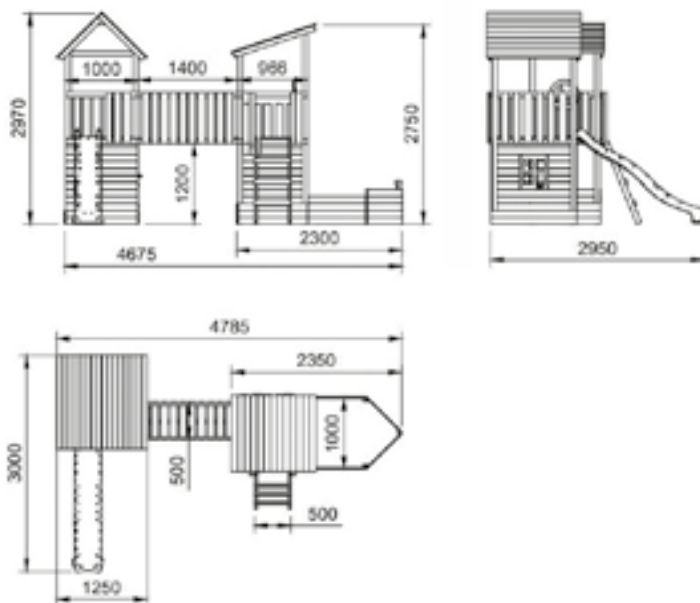

ATLANTIC I

Ref: MA800010



Children's playground PACIFIC

3-12
years



The PACIFIC children's park is a spectacular structure that combines the Tibidabo Tower with an integrated playhouse with the Nautilus Tower, the two towers connected by an elevated bridge.

Tibidabo Tower:

- Elevated structure
- Little house at the bottom of the tower with door and window
- Slide ramp
- Double supported swing frame
- 2 flat plastic seats and ropes
- Anchors, screws and plugs

Elevated bridge

- Wooden bridge structure

Nautilus Tower

- 1 raised house with a sloping roof
- 1 sandbox (without sand) in the shape of a boat
- 1 wooden ladder
- 1 climbing wall with climbing stones
- 1 ship's wheel
- Anchors, screws and plugs

PACIFIC L

Ref: MA800002

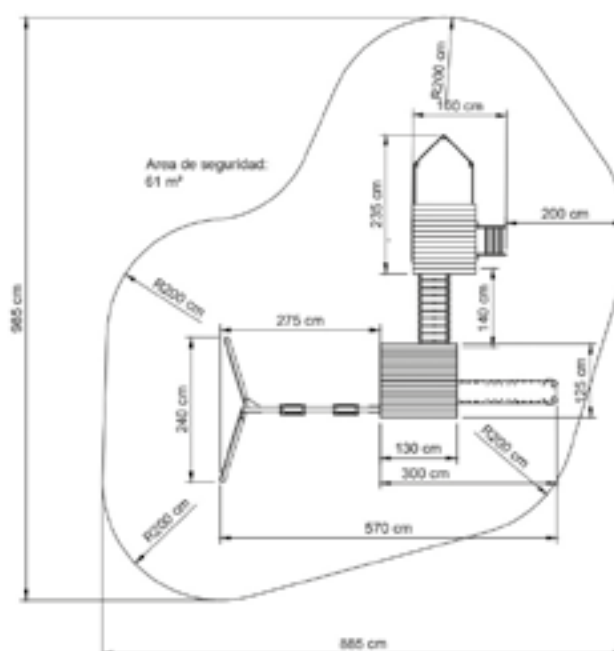

Children's playground USHUAIA

NEW 2025

The Ushuaia XL playground combines the Teide XL and Tibidabo XL models, connected by a wooden Madison bridge, creating a complete and exciting play space for children.

Includes an elevated playhouse with a slide ramp, climbing wall, monkey ladder, picnic table and sandbox (on Teide XL), as well as a playhouse on the ground floor, fireman's pole and access to the upper level (on Tibidabo XL).

Made of high-quality wood, with a weather-resistant HDPE plastic slide, and equipped with anchors for fixing to the ground. In addition, the park can be expanded with accessories such as bells, telescopes or steering wheels for even more fun.

Overall dimensions: 3.05m high, 6.47m long and 2.40m wide.

Platform height: 1.50m. Requires a 2 metre safety zone around. Ideal for outdoor and creative play.



Ref: MA700470



LET'S PLAY!





Children's playground **HIMALAYA**

THEY CAN CONNECT
THE TOWERS AND MAKE
COMBINATIONS
SPECTACULAR!



Penthouse Tower with swing + Kiosk Tower with swing.

Himalaya Park is a mega combination of an XL Penthouse playground + a Kiosk L playpen, both with a double swing. They are connected by a rope bridge Bridge which can be replaced by the Madison rigid wooden walkway. Multiple play areas, two slides, four swings and endless possibilities!



HIMALAYA XL

Ref: MA800001



Optional 0.60 cm slide not included.



Himalaya playground with Madison bridge.

HIMALAYA XL WITH MADISON BRIDGE

Ref: MA800001M

3-12
years

Children's playground SUPERPOP

This spectacular playground is the union of two Lollipop L or XL parks joined by a Madison bridge, so that they are opposite each other.

This is a massive structure, particularly stable, strong, durable and with a multitude of play options. It features two Lollipop XL houses and a single, particularly large elevated play area: the two platforms and the walkway at the same level together provide a large play area.

In addition, this park is available in L or XL sizes, with a platform raised to 120 or 150 cm in height. You can choose a combination of two slides or a slide + a climbing net. The playground has two access stairs, two climbing walls to see who can climb the fastest, and two sandpits: one to fill with sand and the other to store the bike or scooter under one of the houses.

Domestic use.



SUPERPOP L

Ref: MA700450

SUPERPOP XL

Ref: MA700460



Superpop L

Superpop XL

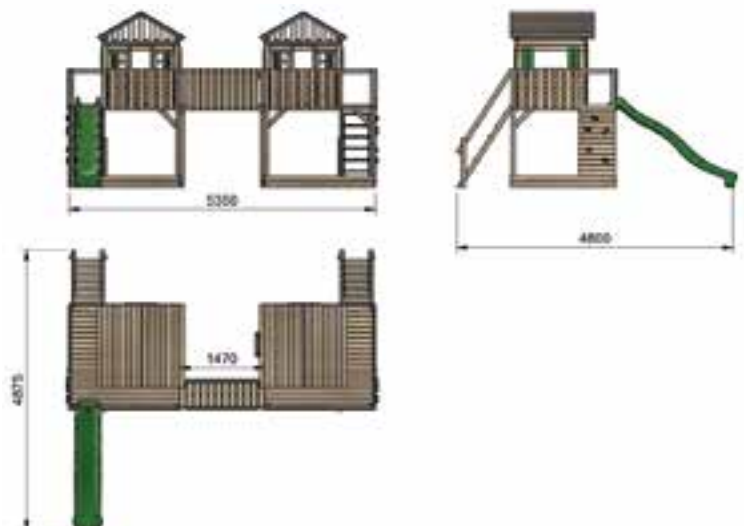



3-12 years

Children's playground BAIKAL

The BAIKAL playground is the result of combining the Beach Hut XL with Challenger and the Crossfit playpens, linked by the Bridge.

This mega park proposal combines two concepts in one: fun and exercise. The Beach Hut area maximises fun with the playhouse and sandbox below, the balcony for greeting, the long slide ramp and a Challenger structure with double swing, climbing wall and climbing net. On the other hand, at the opposite end of the bridge, there is the Crossfit park, an ideal space to exercise the muscles. It has a brachiation ladder (or monkey ladder), two pull-up bars, a huge rope net for climbing next to a new climbing wall and two large platforms for resting.

An ingenious design that combines fun and exercise like no other park.



BAIKAL

Ref: MA800015

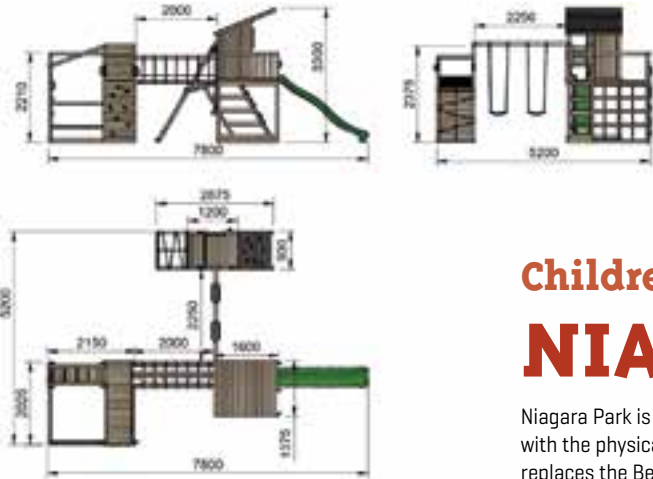

Children's playground NIAGARA

Niagara Park is another great option that also combines the fun of the Tibidabo children's park with the physical exercise offered by the Crossfit park. However, unlike Baikal, Niagara Park replaces the Beach Hut XL tower with Challenger with the Tibidabo XL tower with a double swing and a playhouse, and with a different layout of the space.

It allows for better use of a long, narrow space and the Tibidabo tower with a playhouse underneath increases

the age range of this park, since the youngest children who do not dare or cannot climb to a height of 150 cm can play inside the playhouse on the "ground floor".

De 3-12 años

NIAGARA

Ref: MA800012

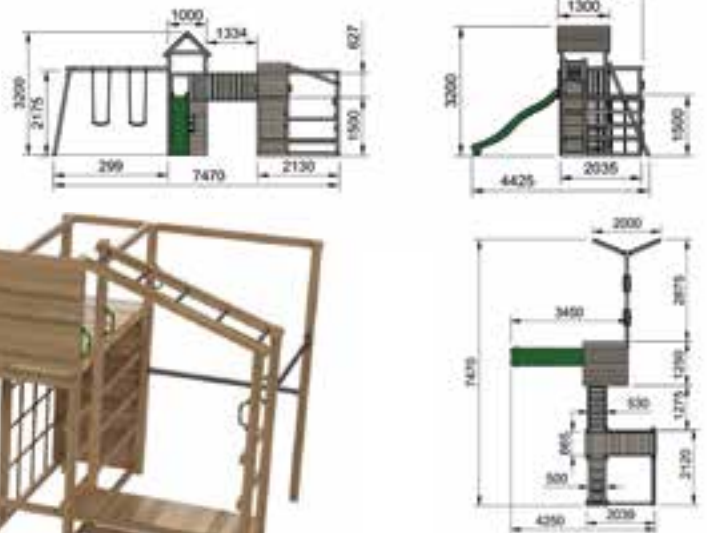

3-12
years

Children's playground

Other combinations



PYRENEES

Combination of Beach Hut L with double swing, Bridge and Kiosk L parks.

Ref: MA800009



ANDES

Combination of Penthouse Parks with Double Swing, Bridge and Kiosk Park L.

Ref: MA800005



APENNINES

Combination of two Kiosk L or XL parks, one of them with a double swing, connected by a Bridge.

APENINOS L

APENINOS XL

Ref: MA800003

Ref: MA800004



ALPS

Combination of the Penthouse parks with double swing, Bridge bridge and Kiosk L Park in a different position from the Andes park.

Ref: MA800006



ATLAS

Combination of Penthouse Parks with Swing, Bridge and Beach Hut Park L.

Ref: MA800007

PLAYGROUND ACCESSORIES

@Challenger

L XL

Ref: MA803701

Ref: MA803801



ADVENTURE

L XL

Ref: MA813701

Ref: MA813801



@Steps

L XL

Ref: MA803001

Ref: MA803002



@Ramp

L XL

Ref: MA804101

Ref: MA804201



@Wall

L XL

Ref: MA803101

Ref: MA803201



@Net

Ref: MA803301



Madison Bridge

Ref: MA803451



@Bridge

Ref: MA804101



Monkey Ladder

Ref: MA700152



Ramp for Mauna Loa

Ref: MA700013



Single swing supported for towers

Square wood.

• 1,20 m

• 1,50 m

Ref: MA700140

Ref: MA700141



Double swing supported for towers

Square wood.

• 1,20 m

• 1,50 m

Ref: MA700150

Ref: MA700151





Bell
Ref. MA513010



Magic mirror
Ref. MA700350



Fireman's Pole
Ref. MA400804



Big ship's rudder
Ref. MA400337



Hoop of Basketball
Ref. MA400803



Large binoculars
Ref. MA400347



Green phone
Ref. MA400810



Red Telephone
Ref. MA400801



Large telescope
Ref. MA400327



Set stones of climbing (5 pieces)
Ref. MA700347



Red Mailbox
Ref. MA400901

ONE TOWER PARKS		SUPPORTED SWING				CHALLENGER		ADVENTURE		WALL	
		Individual		Double		L	XL	L	XL	L	XL
		L	XL	L	XL						
TIMBU											
DOLOMITES CHALLENGER											
SIBERIA ADVENTURE											
KILAUEA	S										
LOOKOUT	S										
	M	✓		✓		✓		✓			
MILOS	M										
CARLIT	M										
	L					✓		✓			
CASCADE	M	✓		✓							
	L	✓		✓		✓		✓			
MAUNA LOA	L										
MAUNA LOA SQUARE WOOD	L										
LIGNUM	L										
TALAIA	L	✓		✓		✓		✓		✓	
TAGA	L	✓		✓		✓		✓		✓	
NAUTILUS	L	✓		✓		✓		✓		✓	
NAUTILUS + CLIMBING WALL	L									✓	
TIBIDABO	L	✓		✓		✓		✓		✓	
	XL		✓		✓		✓		✓		✓
LOLLIPOP	L	✓		✓		✓		✓		✓	
	XL		✓		✓		✓		✓		
BEACH HUT	L	✓		✓		✓		✓		✓	
	XL		✓		✓		✓		✓		✓
BELVEDERE	L	✓		✓		✓		✓		✓	
	XL		✓		✓		✓		✓		✓
KIOSK	L	✓		✓		✓		✓		✓	
	XL		✓		✓		✓		✓		✓
PAGODA	L	✓		✓		✓		✓		✓	
	XL		✓		✓		✓		✓		✓
PENTHOUSE	XL		✓		✓		✓		✓		
PALAZZO	XL		✓		✓		✓		✓		
TEIDE	XL		✓		✓		✓		✓		
CROSSFIT	XL		✓		✓		✓		✓		
SIRACUSA			✓		✓		✓		✓		

COMBINATIONS OF TWO TOWERS		L	XL	L	XL	L	XL	L	XL	L	XL
ATLANTIC	L	✓		✓		✓		✓		✓	
PACIFIC	L	✓								✓	
PYRENEES	L	✓		✓		✓		✓		✓	
SUPERPOP	L									✓	
	XL										✓
APENNINES	L	✓		✓		✓		✓		✓	
	XL		✓		✓		✓		✓		✓
HIMALAYA	L/XL					✓	✓	✓	✓		✓
ATLAS	L/XL	✓	✓	✓		✓	✓	✓	✓	✓	✓
BAIKAL	XL						✓		✓		✓
NIAGARA	XL		✓				✓		✓		✓
ANDES	XL	✓	✓	✓		✓	✓	✓	✓	✓	✓
ALPES	XL										
USHUAIA	XL										✓

WOOD GAMES

House LOLLIPOP



SIZE L

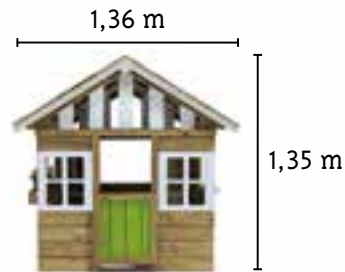
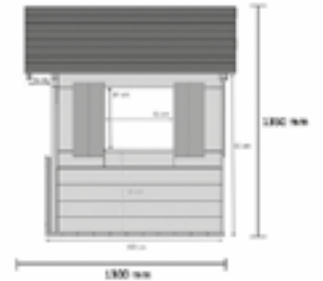

1,55 m



1,64 m

SIZE XL

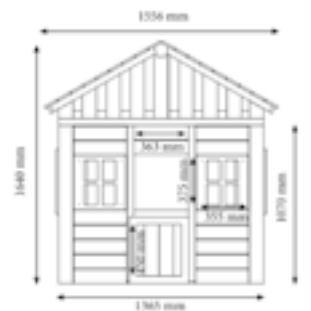

OPTIONAL
CUSTOM
FLOOR



The precious little house Lollipop XL!
WATCH IT HERE!



This fun Lollipop house is available in 4 colors:

Pink, Green, Blue and White.

The Lollipop playhouse is made from treated pine wood for outdoor use from renewable forests. The wood is square-cut, making it very durable. With this playhouse, the littlest members of the family will have their own space in the garden to play, learn, socialize and make friends and, ultimately, develop their abilities in every sense.

External dimensions (width x depth x height): 1360x1300x1350 mm.

PINK L

Ref: MA800521

GREEN L

Ref: MA800523

BLUE L

Ref: MA800525

WHITE L

Ref: MA800527

PINK XL

Ref: MA800541

GREEN XL

Ref: MA800543

BLUE XL

Ref: MA800545

WHITE XL

Ref: MA800547





House LOLLIPOP L ELEVATED

The Elevated Lollipop Playhouse offers lots of fun as children can climb the wooden ladder, play on the platform, slide down and play inside the playhouse. It is made of pine wood treated for outdoor use, very resistant and durable.

The Lollipop elevated playhouse is available in 3 colours and each colour includes a matching coloured ramp.

Ref: MA800533

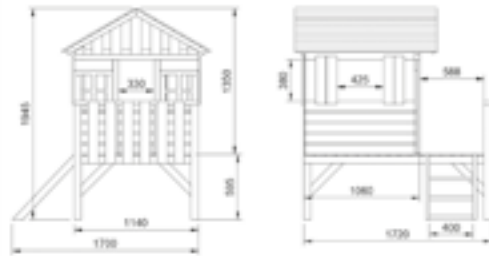

House LOLLIPOP XL ELEVATED

A hybrid playground and playhouse. For small spaces, with a slide for children up to 9 or 10 years old and a playhouse that is more than 160 cm high on its own. All of this on a very strong platform that raises the structure 90 cm from the ground. Only available in green

Ref: MA700420



NEW 2025



Playhouse FLAM

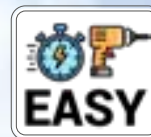

**AT GROUND LEVEL AND
RAISED AT 60 AND 90 CM**



EASY MOUNTING BY PANELS

The **Masgames FLAM** little house is a beautiful little house made of level IV autoclave-treated wood and perfectly suitable for the outdoors. Its beautiful design offers plenty of interior space as well as large windows through which to see and monitor what is happening inside, while also ensuring that the interior play area has plenty of natural light.

The little house **FLAM** It has a window with a comfortable sill and, on the opposite side, another window with a cross through which lots of light comes in. The door is easily accessible and next to it, another smaller window, provides a lovely touch of elegance.

This little house is manufactured in three formats:

- At ground level [with option of installing interior flooring]
- Raised to 60 cm high, with a front balcony and staircase on one side and a small slide on the other.
- Raised to 90 cm height, with front balcony, staircase with railings on one side and 175 cm long ramp on the other.

Available in natural wood colour [unpainted] or painted green.

The profiles of the house are always in white.

House FLAM

Ref: MA800585X

FLAM ELEVATED 60 cm

Ref: MA806585X

FLAM ELEVATED 90 cm

Ref: MA809585X



Plataforma 900mm

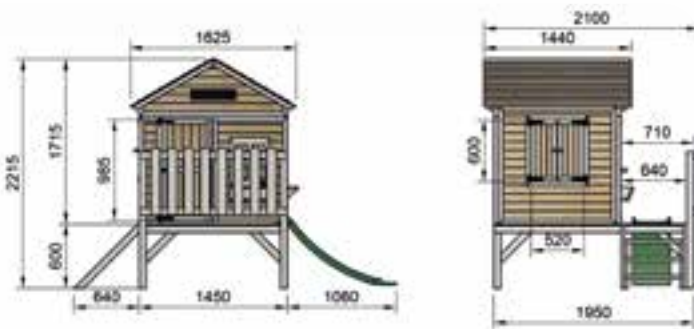

Plataforma 600mm

Playhouse OLDEN



The OLDEN cottage is a charming cottage straight out of a fairy tale. This cottage has details that others don't have, such as a porch with a wooden deck and railing, large opening shutters or the option of choosing it in blue, green or pink.

OLDEN

Ref: MA800590X



What are paneled houses?

VIDEO INSIDE!



EASY MOUNTING BY PANELS



Playhouse

FADA



A Fantasy World for Children!

Transform your garden into a fairy tale with the FADA playhouse! Designed to stimulate imagination and active play, this playhouse offers fun and safety with easy assembly and high-quality materials.

Main Features:

Fairytale design: Open windows, magnetic closing door, fireplace and a charming style.

Easy Assembly: Pre-assembled panels to assemble in minutes with only 6 screws per panel.

Quality and Durability: Made with level IV autoclave-treated wood, ideal for outdoors.

Made here and by us: Like all MASGAMES products, this Fada playhouse is also made of sustainable, durable and safe wood, with spare parts available.

Measures:

Exterior: 145,5 x 169 x 174 cm.

Interiors: 112 x 117 cm.

Give your children a unique space to play, imagine and grow with the FADA playhouse!

Ref: MA800595



Playhouse VISBY



OPTIONAL
SOIL

The MASGAMES VISBY playhouse is a playhouse that kids will love due to its beautiful details, such as fixed and opening windows, generous floor plan dimensions and a high door dominated by two smaller windows, one on each side.

Very easy to assemble as it is delivered pre-assembled in panels and with the option of three different colours!

Also choose whether you want it at ground level or prefer to give it added value by raising it 60 or 90 cm from the ground, along with the corresponding slide!

Ref: MA800583

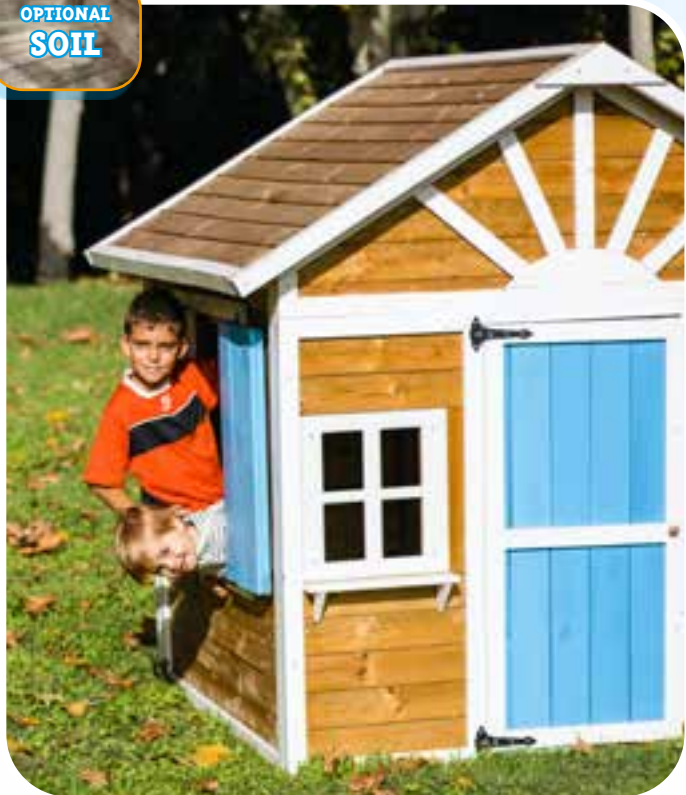

VISBY (60cm height from the ground)



VISBY (90cm H from the ground)



Cottage ANDREA

The MASGAMES ANDREA cottage has simple, modern lines and is inspired by the "less is more" design.

This little house is made of high quality pine wood. The wood used for its manufacture is from renewable European forests, so it is environmentally friendly and very durable, with a treatment against insect pests and to make it resistant to the outdoors. This treatment is free of arsenic.

The roof is made of a very weather-resistant and waterproof canvas so that water does not filter in, although water can enter through the open walls.

The MASGAMES ANDREA playhouse is available in two versions:

ANDREA WITH FLOOR

Ref: MA800565

ANDREA WITHOUT FLOOR

Ref: MA800560



Playhouse STRAWBERRY

A nice, large playhouse that children will enjoy and will be able to play with for many years due to its large size! The Strawberry playhouse includes a door and windows and in its "painted" version it has details painted in red.

This little house is for private use. Made of treated pine wood so that it can be outdoors and protected against pests and rot.

Total dimensions of the house: 194 cm high x 140 cm wide x 148 cm long.

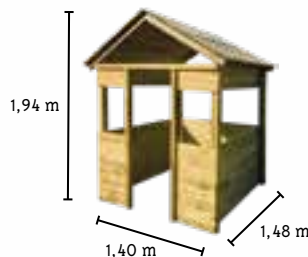

STRAWBERRY XL House

Ref: MA800550

STRAWBERRY House Floor

Ref: MA800552

Measurements 136 cm (length) x 123 cm (width) x 3 cm (height)



Playhouse "Strawberry" XL Deluxe

Ref: MA800575

This version is the most complete because it includes three accessories: a mailbox, a telephone that rings like a real one, and a flowerpot for putting plants.

Children's Kitchen CANDY

The Masgames kitchenette CANDY This is a sturdy and strong wooden outdoor children's kitchen with very pretty plastic details in colours that will blend perfectly into your garden. It includes a tank to fill with water and make the tap really work. It has a sink whose lid is also the worktop of this charming kitchen. The Masgames Candy kitchen can be purchased with all the kitchen utensils in case you already have yours or if you need everything.



WITHOUT UTENSILS

Ref: MA600599

UTENSILS INCLUDED

Ref: MA600599A

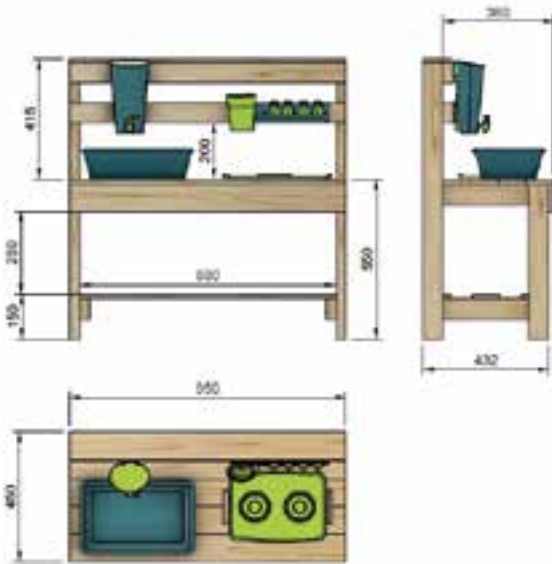

Children's Kitchen SPICY

Spicy Measurements:

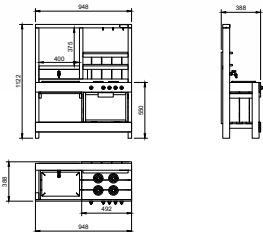

S.Delicious Measurements:

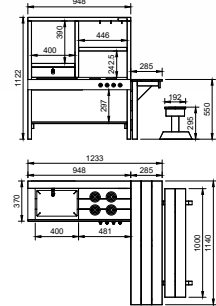

SPICY KITCHEN

Ref: MA600550

• Included are utensils of kitchen.



Discover the kitchen
Spicy Delicious
VIDEO INSIDE!



SPICY DELICIOUS KITCHEN

Ref: MA600575

SANDBOXES

Made of treated wood for outdoor use, very consistent and strong. They include a geotextile barrier to isolate from the ground.



M, L and rectangular BASIC SANDBOX with cover included

SANDBOXs mejorados: Fabricados con madera de 21 mm de grosor (antes 15 mm) para mejorar su resistencia.

BASIC M

Sandbox **square** Available in two sizes:

M: 1,20 m x 1,20 m

Ref: MA600050

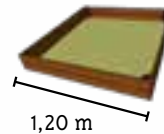

BASIC RECTANGULAR

Sandbox **rectangular**:

1,50 m x 1,20 m

Ref: MA600052

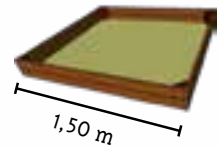

BASIC L

L: 1,50 m x 1,50 m

Ref: MA600051

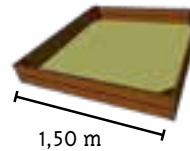

Deck **sandbox square**:

M: 1,20 m x 1,20 m

L: 1,50 m x 1,50 m

Sandpit cover **rectangular**:

1,50 m x 1,20 m

OBEN SANDBOX with wooden cover

Sandbox with a wooden lid and comfortable handles for opening and closing to keep the sand protected and prevent it from getting dirty. Includes handles for easier placement.



Masgames sandbox

OBEN:

FUN IN THE SAND!



Available in 3 sizes:

- Oben M sandbox: 1,20 x 1,20 m.
- Oben sandbox L: 1,50 x 1,50 m.
- Oben Rectangular Sandbox: 1,20 x 1,50 m.

Ref: MA600090

Ref: MA600091

Ref: MA600092



TECTUM SANDBOX with folding cover

Practical sandbox with a folding cover that transforms into two benches so that children can sit and when they have finished, they can cover the sand with the lids to prevent it from getting dirty.

Made of pine wood treated for outdoor use.

Suitable for private use.

Measures:
118,5 cm [largo] x 118,5 cm [ancho]
x 21 cm [alto]

Ref: MA600100

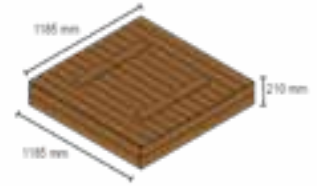

KASSI SANDBOX with bench / drawer

Very functional wooden sandbox available in three sizes: M, L and Rectangular. The KASSI sandbox has a drawer for storing toys that also serves as a practical bench for comfortable play.

KASSI M Square sandbox:

1,20 m x 1,20 m

Ref: MA600080



KASSI L

1,50 m x 1,50 m

Ref: MA600081



RECTANGULAR KASSI

1,50 m x 1,20 m

Ref: MA600082

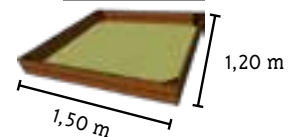

GOALS

M GOAL



MASGAMES goal, for football lovers who want to practice their skills with the ball.

Made of square pine wood, weather resistant.

Includes mesh and ground anchors, so that it remains securely fixed to the ground.

This goal complies with European regulations EN71-8 for private use.

Measurements Goal M: 180 x 120 x 60 cm

Ref: MA209013

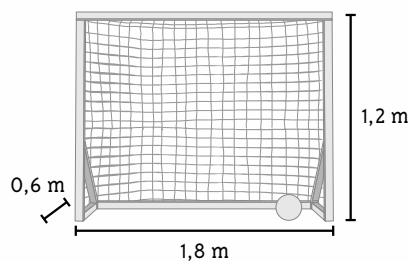

L GOAL

MASGAMES goal, for football lovers who want to practice their skills with the ball.

Made of square pine wood, weather resistant.

Includes mesh and ground anchors, so that it remains securely fixed to the ground.

This goal complies with European regulations EN71-8 for private use.

Goal measures L: 220 x 180 cm

Ref: MA209016

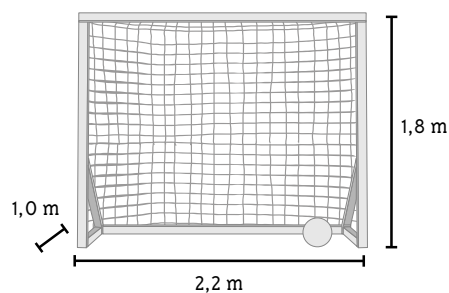



XL GOAL

MASGAMES goal, for football lovers who want to practice their skills with the ball.

Made of square pine wood, weather resistant.

Includes mesh and ground anchors, so that it remains securely fixed to the ground.

This goal complies with European regulations EN71-8 for private use.

Medidas Portería L: 300 x 200 cm

Ref: MA209017

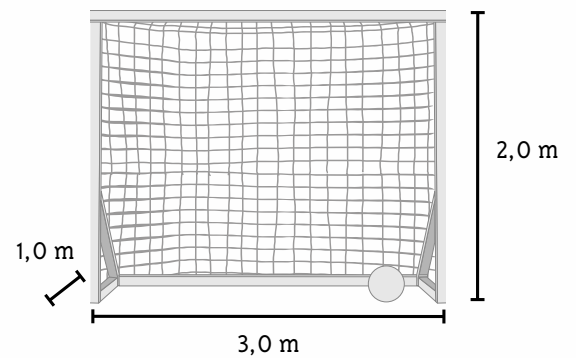

ZIPLINE

Zipline set with plastic seat for home use.

Zip line for private use made of galvanized steel painted dark green on the outside. The internal parts are made of resistant plastic and each side has a handle covered with a soft, non-slip material.

The cable is made of galvanized steel, 30 meters long, which must be fastened between two strong supports or two trees and must be tightened using a galvanized iron tensioner (included).

Includes brake to prevent collisions.

It can be used in two ways, by grabbing the side handles or using the included plastic seat.

Includes green plastic seat and synthetic rope.

- Maximum user weight 70 kg
- Suitable for children aged 3 to 12 years.

Ref: MA400308



GROWING TABLE

FORTIS

Growing table. Made from wood treated for exterior use [autoclave level IV] from renewable European forests.

These growing tables are very robust and include a geotextile barrier to protect the wood from the soil.

All growing tables are sent with 4 seed envelopes for planting.

Available in 3 sizes:

- **FORTIS Junior cultivation table:** 798 mm long x 418 mm wide x 500 mm high
- **FORTIS L cultivation table with legs:** 998 mm long x 568 mm wide x 850 mm high
- **FORTIS L cultivation table without legs:** 998 mm long x 568 mm wide x 336 mm high



FORTIS HIGH

Ref: MA600702



FORTIS JUNIOR

Ref: MA600700



FORTIS LOW

Ref: MA600701



Se incluyen 4 sobres de semillas
(con el pack de 3 mesas de cultivo)



Outdoor chalkboard LAPITZ

The wooden blackboard for outdoors LAPITZ. It is a game made of solid, quality wood. It is a strong and resistant product, also outdoors. The board is a large methacrylate plate where boys and girls can paint on both sides of it. Methacrylate is a very transparent, recyclable plastic that is easy to clean when painted on.

The board has a base where you can leave markers and paints while boys and girls have fun with it.

Measurements: 1040 mm long x 390 mm wide x 1185 mm high.

Painting material is not included.

Ref: MA600500

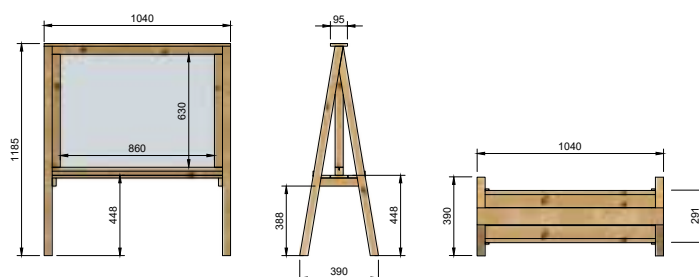

View the board Lapitz
in your garden,

IN THIS VIDEO:



SLIDES

MOLA

The Masgames slide **MOLA**. It has a structure made of weather-treated wood. This slide for home use is very strong and stable and is available in two sizes: L and XL. In both cases, the slide ramp [232 and 295 cm long respectively] has a hose connector so that in summer they can be converted into refreshing water slides.



MOLA L:

Ref: MA600020

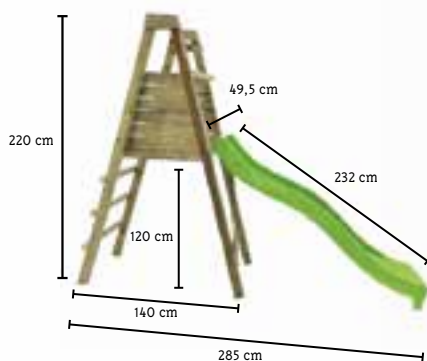

MOLA XL:

Ref: MA600030

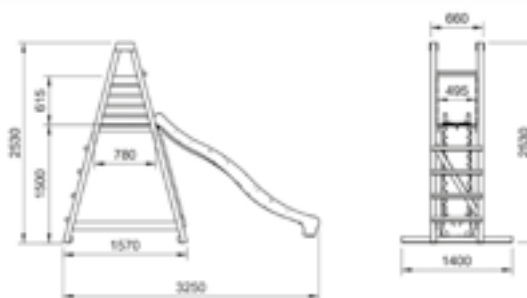

TUCA

The Masgames slide **TUCA** and **TUCA XL**. They are metal structures made of powder-coated painted steel with a platform 120 cm high in the L version and 150 cm high in the XL version. From this platform the fun begins with a slide ramp, the size of which also depends on the slide height you choose.

TUCA slides have a modern and minimalist design, are easy to assemble and include anchors for correct installation on dirt or grass.

Optimal stability and guaranteed fun!

- The dimensions of the Masgames TUCA L slide are: 161 cm high (120 to the platform) and 113 cm wide.
- The measurements of the Masgames TUCA XL slide are 191 cm wide. height (150 to the platform) and 143 cm wide



TUCA L:

Ref: MA600010

TUCA XL:

Ref: MA600011



3-9
years



SUI

The SUI slide is a strong and sturdy structure.

With an excellent quality-price ratio.

It is a slide whose structure is made of treated wood with a plastic ramp. **A strong product for private use with side supports to give more stability to the structure.**

- Measurements:
2.40 m [length] x 1.40 m [width] x 1.80 m [height]
 - Platform height: 1.20 m
 - Recommended for children aged 3 to 9 years.
 - Includes metal connecting parts, anchors and the screws.
- Approved for private use.

SUI:

Ref: MA600015

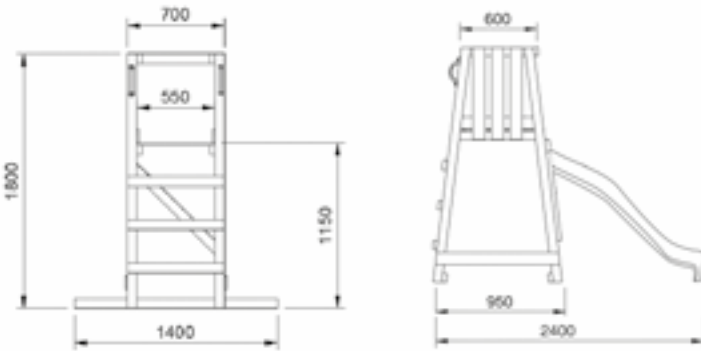

**slide ramp
0,60 m
(height)**

GREEN Ref: MA604166
PINK Ref: MA604167
BLUE Ref: MA604168



**Slide ramp
0.90 m
(height)**

Ref: MA604173



**Slide ramp
1.2m
(height)**

GREEN Ref: MA604169
PINK Ref: MA604169R
BLUE Ref: MA604169A



**Slide ramp
1,5m
(height)**

Ref: MA604174



**Removable
slide ramp
TRIX 1.5m**

Ref: MA604333



**Slide ramp
3m various colors**

Ref: MA60417X



PRODUCTS FOR COMMERCIAL USE

Horeca Channel

THE PRODUCTS OF THE HORECA CHANNEL ARE INTENDED FOR COMPANIES IN THE HOTEL INDUSTRY, SCHOOLS, NEIGHBORHOOD COMMUNITIES, or public spaces under surveillance. This range of games provides a solution for those clients who, by regulation, must install a game approved for public use but do not need the game to be vandal-proof, since it will not be exposed to possible acts of vandalism as can happen in municipal parks, town halls or very large schools.



Made of autoclave-treated pine wood, Borealis playground is a children's playground with a slide and complies with the EN1176 regulations for restaurants, rural houses, campsites, etc

BOREALIS Children's playground

With a platform height of 1.50 mts. and very resistant plastic made in painted or unpainted.

Ref: MA500920 BOREALIS OPTIMA (unpainted)

Ref: MA500940 BOREALIS GREEN OPTIMA

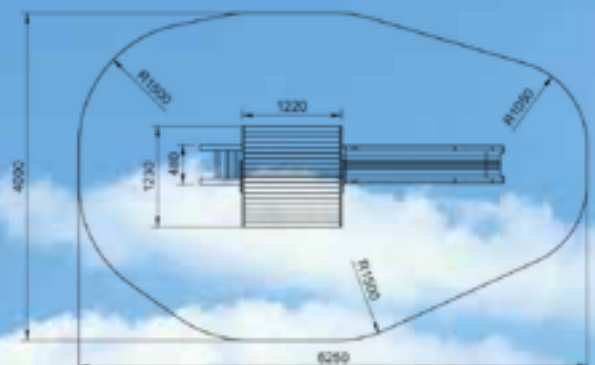
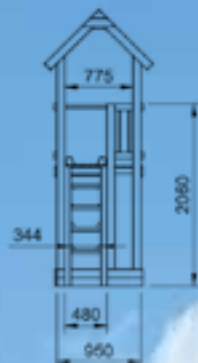
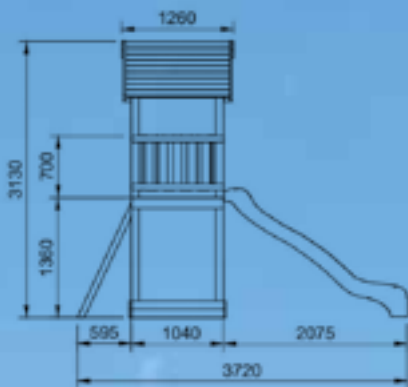

PYXIS

Children's playground

The PYXIS tower is a very robust wooden playground that complies with EN1176 regulations so it can be installed in Hotels, Restaurants, Rural Houses, Campsites, etc. It is made of autoclave IV treated pine wood suitable for outdoor use.

The PYXIS tower has a wider platform and includes a small house at its base with an entrance (without a door), open windows, a counter-top and an interior L-shaped bench so that children can sit inside.

PYXIS OPTIMA

Ref: MA500930

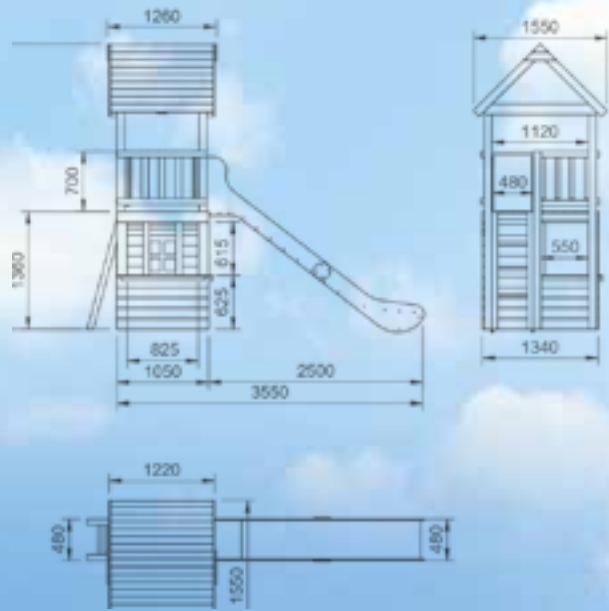

LOLLIPOP

Children's playground

The LOLLIPOP HORECA children's playground is a structure that we have reinforced with thicker wood than that of the playgrounds for domestic use. For example, the railing slats go from 15 mm thick to 21 mm thick or the wood of the pillars go from 68x68 to 88x88 mm. Even the screws of the structure change.

This playground complies with the European regulation for commercial use EN-1176 and is therefore suitable for installation in Hotels, Restaurants, Campsites, Schools and for demanding clients.

The LOLLIPOP HORECA children's playground combines the Lollipop XL Horeca playhouse with a spectacular elevated structure that includes the playhouse with fixed windows, stairs, balcony with railing, climbing wall and sandbox in the inner part [without sand].

Ref: MA500975

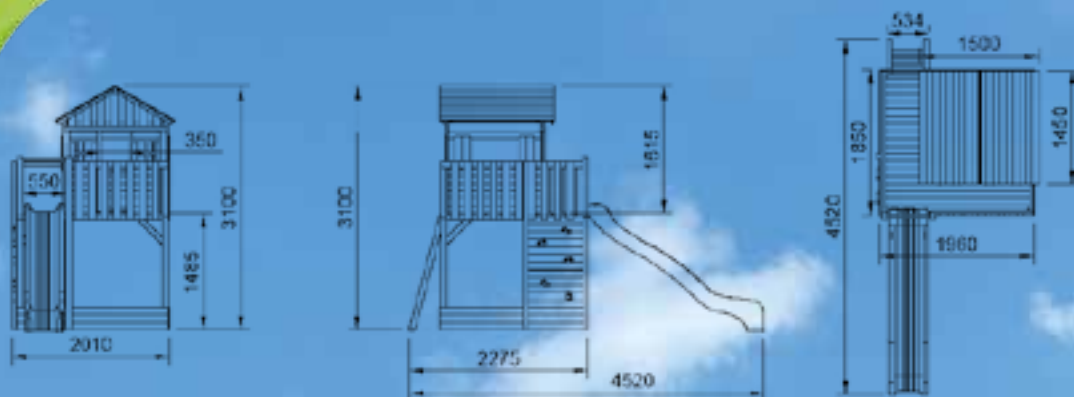

AURORA BOREAL

Children's playground

The AURORA BOREAL children's playground consists of a roofed tower with a slide ramp that children can slide down. It also includes a wooden bridge to connect to the other tower and a tower with double access via a climbing ramp or a ladder for easy access. At the base of both towers you can add sand [not included] and have two sandboxes.

Aurora Boreal playground measurements:

- 6.63 m. long x 1.60 m. width x 3.13 m.
- Platform height: 1.36 m.

Ref: MA500985

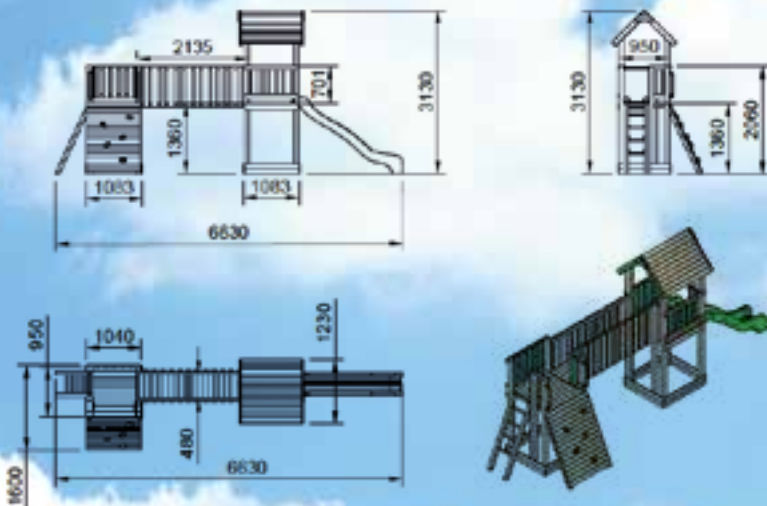

LITTLE HOUSES DOBLEPOP CON PLATAFORMA

Composition of two Lollipop XL Horeca houses in which you can choose the colour (green, blue, pink or white), both in the same colour or combining colours. These two houses include a triple platform reinforced with pillars that makes it very safe and resistant.

The Doblepop combination is a very robust wooden structure and complies with the EN1176 regulations so that it can be installed in Hotels, Restaurants, Rural Houses, Campsites, Homeowners' Associations, Schools, etc.

Measurements of the Doublepop platform playhouses:

5.07 m. long x 1.83 m. wide x 2.22 m. high. Platform height: 0.60 m.

Ref: MA500990



Playpen **PEGASUS**

The PEGASUS playground with the OPTIMA slide ramp is a strong and robust playground, with an excellent quality-price ratio. This playground is approved for commercial use and can be installed in Hotels, Campsites, Restaurants, Schools, Homeowners' Associations and also for individuals looking for quality products.

The OPTIMA slide ramp is made of highdensity polyethylene (HDPE), which makes it very strong and resistant.

Ref: MA500115

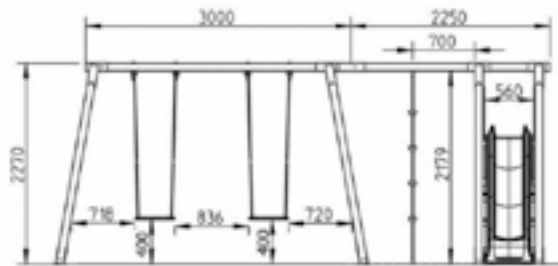

Children's slide **ZENTAURUS**

The ZENTAURUS OPTIMA children's slide is a square wooden structure specially treated for outdoor use. The wood is highly resistant to inclement weather as well as to the continuous use that any commercial game must endure.

Ref: MA500110

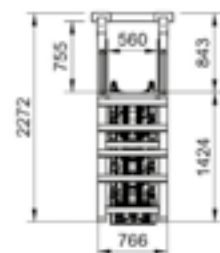
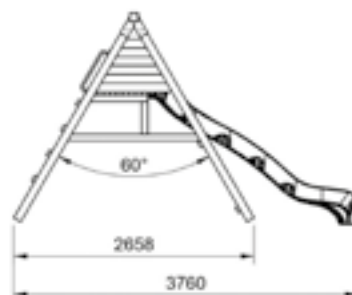

Slide ramp OPTIMA

Replacement slide ramp approved for public use (Horeca).

Made of high-density polyethylene, in a fun green color and available in three heights:

- For 100 cm de height.
- For 120 cm de height.
- For 150 cm de height.

Optima HEIGHT. 100 cm.

Ref: MA604740

Optima HEIGHT. 120 cm.

Ref: MA604745

Optima HEIGHT. 150 cm.

Ref: MA604750

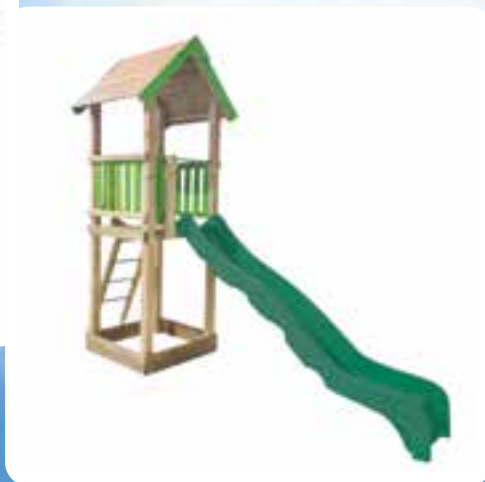

Range PINXO TRAIN

Pinxo Train is a combination of a Pinxo Locomotive and two train wagons that can be purchased separately or install as many wagons as you want.

This fun game allows little ones to get on and off the train, go through the tunnel at the front of the locomotive and helps encourage symbolic and team play.

If you choose to add wagons, the game multiplies!

Both the locomotive and the carriages are large, almost two metres long and just under 1 metre wide.



PINXO train
(Locomotive + two wagons)

Ref: MA500803

Locomotive PINXO

Ref: MA500801

**YOU CAN PASS INSIDE
FROM THE BOILER,
LIKE A TUNNEL!**

Pinxo Train is made with level IV autoclave treated wood and their posts are 88x88 millimetres thick.

They are approved for public use and are an ideal game for a school or tourism and catering companies.

A good alternative to the classic children's playhouse, with hardly any critical fall height, with added value and **very funny!** Gather as many cars as you like and create a play area to encourage group fun.

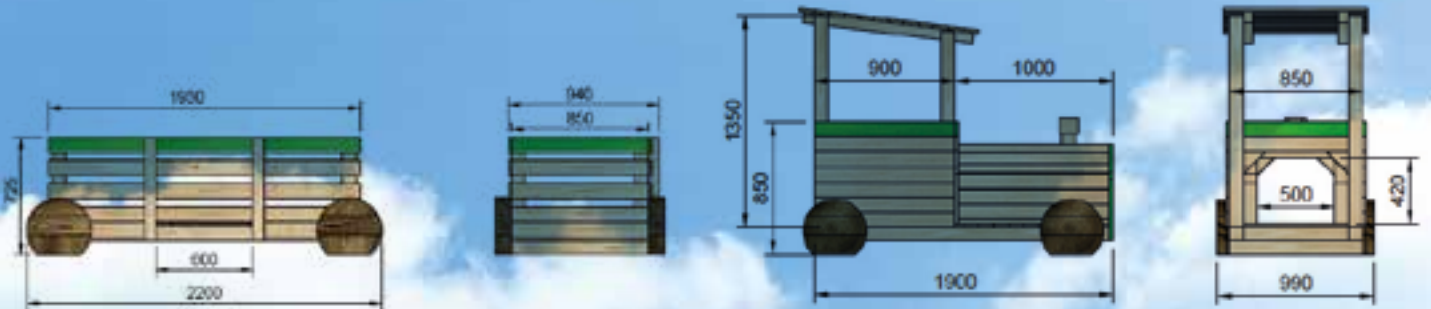

PINXO wagon

Ref: MA500802

POSSIBILITY OF ADAPTING AN ACCESS RAMP TO THE LOCOMOTIVE FOR ACCESS IN A WHEELCHAIR!

★★★★★
5 STARS
INSECTS
Hotel

NEW 2025

Promote biodiversity and environmental education with this shelter designed for green spaces in schools, town halls and hotels. Made from sustainably sourced, treated outdoor wood, it guarantees 10-year durability and offers six compartments with natural materials that attract various species of insects, from bees to ladybugs.

It is easy to assemble and offers the option of purchasing only the structure to fill it with materials from the environment or purchasing the structure with all the materials to fill it.

Ref: MA912024

This hotel is ideal for educational activities and environmental awareness. Includes anchors for secure fixing and ensures effective installation facing south or southeast.

Turn your garden into a biodiversity sanctuary and participate in environmental conservation!

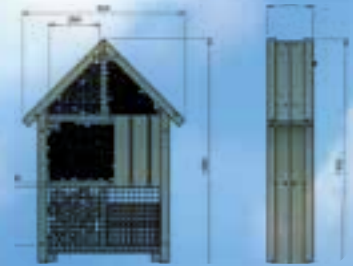

NEW 2025

Nest box
SPARROW

The MASGAMES SPARROW nest box is made from treated wood for outdoor use, designed to hang from trees (iron wire not included). Its sturdy and durable construction ensures years of outdoor durability, providing a comfortable and safe shelter for birds.

Main features:

Thick wood (21 mm): Ideal insulation against cold and heat.

Level IV autoclave treatment: Weather resistant for up to 10 years, arsenic free and safe for animals.

Functional and safe design: Developed according to recommendations from ornithologists. Easy maintenance: Folding roof for cleaning and inspection.

Easy assembly: Instructional video included.

Adjustable hole measurements: Adaptable to different species.

Dimensions: 162mm (length) x 120mm (width) x 258mm (height).

A reliable, durable and comfortable birdhouse. Ideal for hanging and enjoying nature.

Ref: MA600650



Swing VEGA

Swing structure that includes two rubber seats with "Classic" model chains, anchors, screws and plugs.



Ref: MA500105-B



Ref: MA500105
Swing Vega
HORECA

Ref: MA500105
Swing Vega Baby
HORECA

Ref: MA500105

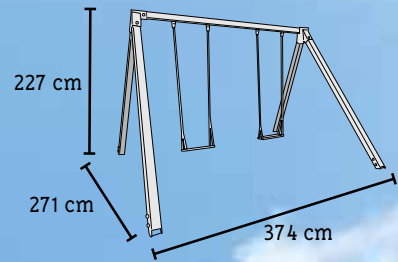

Swing DRACO

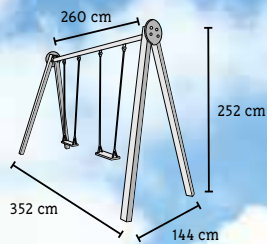

Draco swing is a very strong and resistant structure. It is a combination of a galvanized and dark green lacquered steel beam and four pine wood legs treated in an autoclave level IV. The galvanized steel screws protected with nylon caps and the green trim make this a highly resistant swing for commercial spaces.



Swing Draco Baby HORECA

Ref: MA500107-B



Swing Draco HORECA

Ref: MA500107

Playhouse LOLLIPOP HORECA

This fun Lollipop playhouse is available in 3 colours: Pink, Green and Blue. The Lollipop playhouse is made from treated pine wood for outdoor use, sourced from renewable forests and cut into a square shape, making it very strong and durable.

The windows are made of high-density polyethylene in white. These panels are fixed and very strong and can be easily cleaned with a cloth. They do not require maintenance and even when exposed to the elements, the material does not degrade or lose color.

Optionally, you can purchase flooring to make the playhouse cleaner and more comfortable inside, so that the children will not be in direct contact with the grass or dirt.

Characteristics:

Recommended for children over 3 years old.

Material: Treated wood for exterior use.

Window: Multiple fixed open windows

Roof: Gabled.

External dimensions (width x depth x height): 1540x1450x1640 mm.

The MASGAMES LOLLIPOP HORECA playhouse has interior dimensions of 133x119 cm

Complies with European safety regulations EN1176



PINK

Ref: MA500556

GREEN

Ref: MA500557

BLUE

Ref: MA500555

Playhouse SCHOOL

This children's playhouse is suitable for commercial use and for the Horeca Channel and can be installed in schools, restaurants, hotels, campsites, communities of owners, etc. It is a large playhouse with windows and an entrance. The little ones will be able to enjoy and play using their imagination.

The MASGAMES XL School Playhouse is made of high-quality pine wood. The wood used for its manufacture comes from renewable European forests, which is why it is environmentally friendly and very durable, with a treatment against insect pests and to make it resistant to outdoor use. This treatment is free of arsenic. It complies with the European safety regulations EN1176.

House "School" Paint



Ref: MA500552

House "School" Unpainted



Ref: MA500551

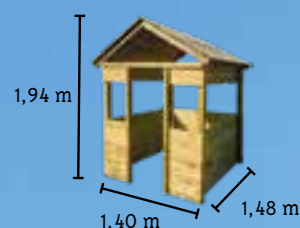

Playhouse LOLLIPOP XXL HORECA

The impressive Masgames Lollipop XXL playhouse is even bigger! With more than 2 metres in height and 3 square metres of interior surface, it is a large playhouse ideal for hosting hours of play at any age and environment. It is approved for commercial use to be installed in schools, hotels, campsites, communities of owners, etc.

This playhouse also has the option of adding an outdoor kitchen to multiply the play options! The outdoor kitchen is just as durable as the playhouse and the set is also approved for commercial use.

This little house, like the rest of the little houses in the Lollipop series, is made in green, pink and blue and if you buy the little kitchen, it also matches.



LOLLIPOP XXL

Ref: MA50065X

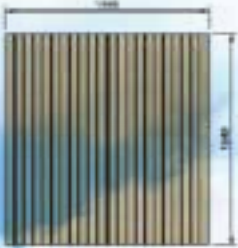
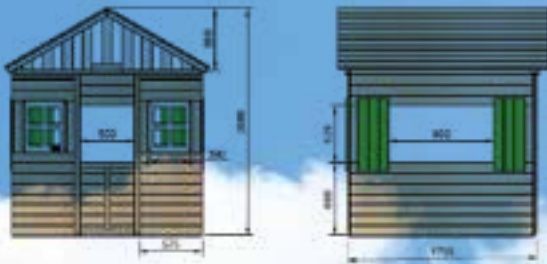

LOLLIPOP XXL WITH KITCHEN

Ref: MA500065X



Playhouse **FLAM**



NEW 2025

This beautiful little house is approved for installation in schools, hotels, residential communities or other public/commercial spaces.

It has a careful design, with a different window on each side. On the left, there is a green cross to give it a touch of color.

The entrance, without a door to avoid the risk of trapping fingers, is moved to one side and leaves space for a smaller polyethylene window.

Unlike the rest of the approved houses, the Flam Horeca is made of tongue and groove wood and PANELS. Therefore, its assembly is easier and faster.

Ref: MA500640



Outdoor kitchen **SPICY**

SPICY KITCHEN

Ref: MA600550

SPICY DELICIOUS
KITCHEN

Ref: MA600575

- These products include anchors for fixing products to the ground.
- Kitchen utensils are included.



SKOLI SANDBOX



MASGAMES SKOLI sandbox, designed to offer endless hours of entertainment with maximum safety and durability.

Approved for schools, the Horeca sector or public spaces!

A solid and sturdy construction made from level IV and exciting environment for the little ones. autoclave-treated wood with 88x88 mm slats, the Skoli sandbox is designed to withstand continuous outdoor use.

Its green polyethylene corners, in addition to providing a touch of colour, ensure the protection of children during play.

Includes anchors to fix it firmly on dirt or sand floors, guaranteeing stability and safety in each game session.

Two dimensions available

Size L: 208.8cm [L] x 208.8cm [W] x 17.6cm [H] Size XL:
248.8cm [L] x 248.8cm [W] x 17.6cm [H]

Whether in schools, hotels, campsites, residential communities or private gardens, the MASGAMES SKOLI sandpit creates a safe and exciting environment for the little ones.

Recommended age: 1 to 6 years.

2 m x 2 m

2,40 x 2,40 m

Ref: MA500170

Ref: MA500175



Wooden FENCES

The wood of the fences is treated for outdoor use in a level IV autoclave, which makes it weather-resistant, both in the sun and in the rain, and even in irrigation. The wood has a 10-year guarantee against rot and pests. You can choose the finish of the fences: unpainted or painted in: green, pink, blue or mixed colours.

Fence RECTA 80

Ref: MA500400

Fence MERLET 80 y 100

Ref: MA500420

Ref: MA500440

Fence MERLET 100 PLUS

Ref: MA500460

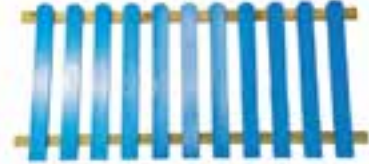

ACCESSORIES

Public use



Public use
rubber and
chains swing
seat

Ref: MA512366



OPTIMA
slide ramp

Ref: MA604750



Public use
rubber and
INOX CHAINS
swing seat

Ref: MA512400



Public use
rubber and
chains swing
baby seat

Ref: MA513769

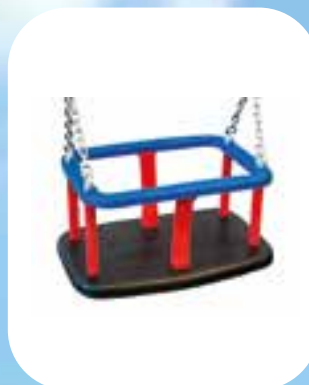

Public use
rubber and
INOX CHAINS
swing baby
seat

Ref: MA512450

GEODESIC DOME

The MASGAMES wooden geodesic dome combines design and functionality. Its semi-spherical structure, made up of interconnected triangles, ensures exceptional rigidity and uniform distribution of loads. This makes it a durable and resistant option, perfect for outdoors.

Made from level IV autoclave-treated outdoor wood, the dome is resistant to rain, sun and snow, ensuring a long lifespan. In addition, we use wood from renewable forests in northern Europe, committed to caring for the environment.

Designed without doors to maintain its strength, this dome is ideal as an outdoor climbing wall, outdoor hut or play space. Its design encourages children's creativity and psychomotor development as they explore its fascinating wooden structure.

Easy assembly: The pieces are delivered pre-assembled and are designed to be assembled by two people with basic tools.



Available in two sizes (vary in diameter and height)

Model L:
Diameter: 203 cm
Height: 102 cm

Ref: MA500991

Model XL:
Diameter: 316 cm
Height: 158,5 cm

Ref: MA500992





KAMBA ROCKER

KAMBA rocking chair with excellent value for money.

Made from high quality square wood, with stainless steel grip handles, injected EPDM rubber seats, two SBR rubber shock absorbers and galvanized steel hinge and screws.

Approved for public and commercial use, EN-1176/77.

- Dimensions: 250 x 40 x 45 cm

Ref: MA500150



SPRINGS



Rocking chair with spiral spring and animal-shaped figure made of 19 mm solid polyethylene. The handles and foot supports are made of plastic with an anti-slip profile. Suitable for hotels, campsites, tourist sites, restaurants... These models are highly recommended for residential communities. RWTUV certified for quality and approved for public use [EN1176]

KUKET DOCK MEASUREMENTS

- Spring dimensions: 1,8 cm x 17,0 cm x 36,0 cm.
- Seat dimensions: 32 cm x 19 cm x 50 cm
- Total dimensions: 70 cm x 50 cm.
- Includes the spring, anchor, screws, plugs, handles and footrest.

Ref: MA500031

GIANT LETTERS

ALPHAPLAY



By Masgames

MASGAMES ALPHAPLAY giant wooden letters. They give meaning to public spaces by providing identity to parks, gardens or squares. In addition to their playful function, these letters convey powerful messages, whether highlighting the name of a town, company, organization or expressing universal values such as LOVE or PEACE. Their versatility allows for unlimited customization, including interactive games on the letters themselves such as climbing walls, slides, swings or play panels. Made from sustainable wood from Northern Europe treated in an autoclave level IV, these letters stand out for their quality and weather resistance.

Their charm lies in encouraging interaction and creativity, attracting visitors of all ages to pose next to them.

The photos taken become memories that are sure to be shared on social media, expanding the magic of the space. They comply with safety regulations for public use and add a touch of natural elegance to the environment.

Each letter, with an imposing height of 200 cm, is made to order and goes beyond being simple games:

they become the essence of outdoor spaces by beautifying, entertaining and communicating, building lasting memories and transcending expectations.

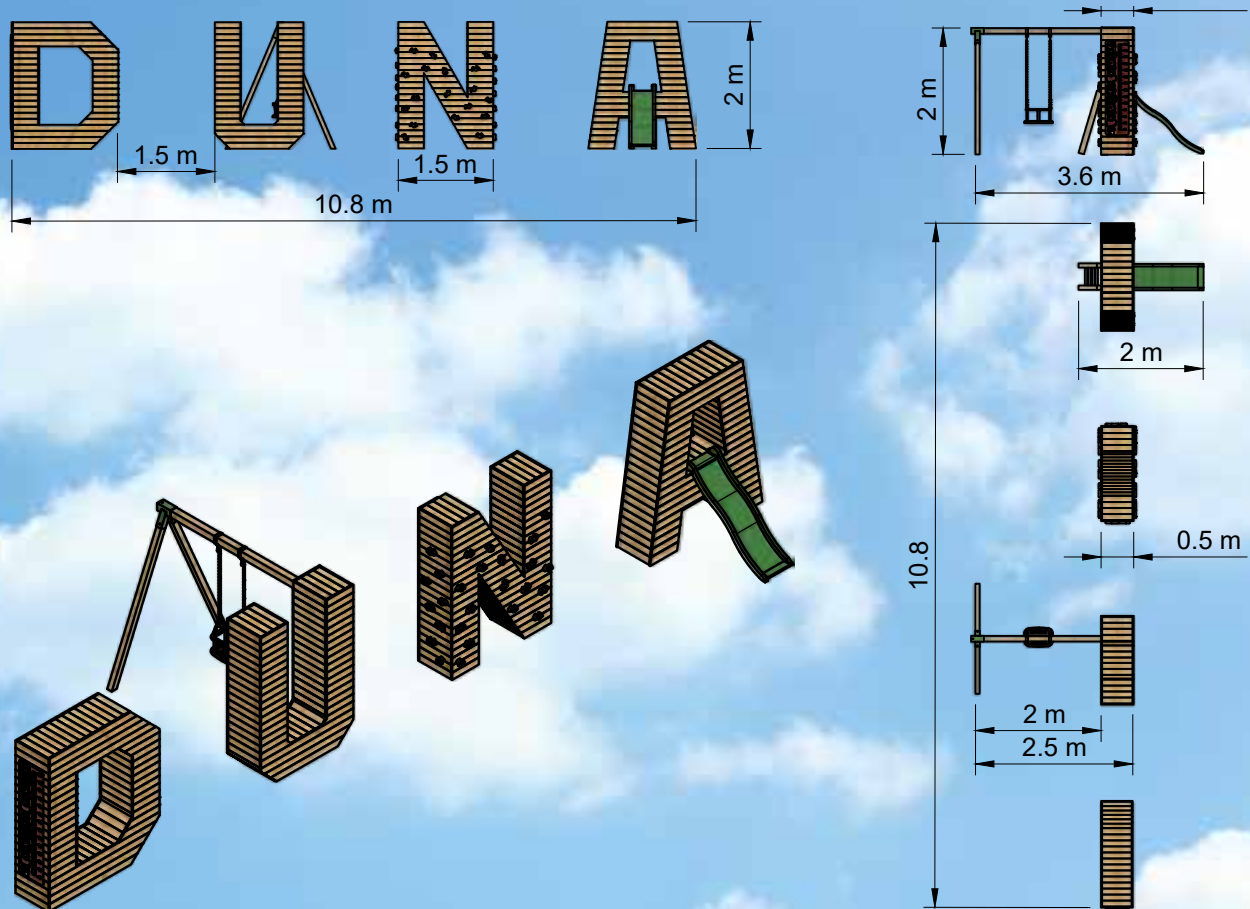

CUSTOM MADE PRODUCTS

At Masgames we are manufacturers of games and outdoor furniture, but we like to work on the design and implementation of specific projects if they have synergy with the products we manufacture.

Do you have a project in mind? Our team of engineers and designers are here to make it a reality!

Tell us what you want, how you imagine it and how much space you have available and we will study it to make you a proposal that will surprise you.

At Masgames we understand that making a custom project involves completing the entire process until you have it installed and ready to use. We will accompany you in the design, we will present you with one or several proposals to adapt to what you really want and, once we have defined it, we will manufacture it so that the result even exceeds your expectations.

In this section of our catalogue we present some of the custom projects we have created: a chicken coop, a rabbit hutch and a wooden children's playground for the interior area of a hotel.

Chicken coop

Rabbit hutch



Can you imagine spending a weekend with your family in a country house where the little ones in the house can play non-stop? Slides, swings, playhouses, adventure towers, going up, going down and spending the day playing, without screens, moving, getting tired and always enjoying the outdoors and nature.

Now add a space where rabbits and chickens can live freely in a space designed for them and protected. Children will come to look around, learn to respect animals and discover the cycle of life.

This was the proposal we launched for this project. An area reserved for these fun animals that, together with a good recreational proposal, offers the little ones the possibility of playing and learning at the same time



Drone circuit

Flying drones is not limited by age or skill. After some explanation, everyone can be able to pick up a controller and make a drone get off the ground and fly.

But there is a world between getting a drone off the ground and piloting it well, having the skill to take your drone wherever you want and flying it wherever you want.

When this moment of absolute control of your drone arrives, the best way to enjoy an exciting flight is flying it on a circuit specially designed for it.



Indoor Park for hotel



This hotel had a beautiful interior space to transform it into a wooden castle with various heights and slides.

From this idea came this spectacular play area with two slides one with a spiral tube slide and a complex wooden structure customdesigned especially for this corner.

The result? A spectacular play area that even the little ones won't want to leave.

What a vacation!

